



User Manual

for S6 Series Hybrid Inverter



Applicable models

S6-EH3P29.9K-H-AU

S6-EH3P30K-H-AU

S6-EH3P40K-H-AU

S6-EH3P50K-H-AU

Applicable System

Three phase system

Important Notes

- Due to the product development, the product specifications and functions are subject to change. The latest manual can be acquired via <https://www.ginlong.com/global>. Every attempt has been made to make this document complete, accurate and up-to-date. Individuals reviewing this document and installers or service personnel are cautioned, however, that Solis reserves the right to make changes without notice and shall not be responsible for any damages, including indirect, incidental or consequential damages caused by reliance on the material presented including, but not limited to, omissions, typographical errors, arithmetical errors or listing errors in the material provided in this document.
- Solis accepts no liability for customers' failure to comply with the instructions for correct installation and will not be held responsible for upstream or downstream systems Solis equipment has supplied.
- Please notice: The system installed as required by Solis, the warranty is only effective for Solis inverter, and other accessories are not guaranteed by Solis warranty.
- The customer is fully liable for any modifications made to the system; therefore, any hardware or software modification, manipulation, or alteration not expressly approved by the manufacturer shall result in the immediate cancellation of the warranty.
- Given the countless possible system configurations and installation environments, it is essential to verify adherence to the following:
 - There is sufficient space suitable for housing the equipment.
 - Airborne noise produced depending on the environment.
 - Potential flammability hazards.
 - Solis will not be held liable for defects or malfunctions arising from:
 - Improper use of the equipment.
 - Deterioration resulting from transportation or particular environmental conditions.
 - Performing maintenance incorrectly or not at all.
 - Tampering or unsafe repairs.
 - Use or installation by unqualified persons.
 - This product contains lethal voltages and should be installed by qualified electrical or service personnel having experience with lethal voltages.

1. Introduction	01-04
1.1 Product Overview	01
1.2 Inverter Wire Box and Connection Points	02
1.3 Product Features	03
1.4 Packaging	04
1.5 Tools Required for Installation	04
2. Safety & Warning	05-07
2.1 Safety	05
2.2 General Safety Instructions	05
2.3 Notice for Use	07
2.4 Notice for Disposal	07
2.5 Notice for Transportation	07
3. Installation	08-40
3.1 Select a Location to Install the Inverter	08
3.2 Product Handling	10
3.3 Mounting the Inverter	11
3.4 Inverter Wiring Overview	13
3.5 Ground Cable Installation	14
3.6 PV Cable Installation	15
3.7 Battery Cable Installation	18
3.8 AC Wiring	21
3.9 CT Connection	22
3.10 Inverter Communication	24
3.11 Diesel Generator Wiring	32
3.12 Parallel System Wiring	35
3.13 Lithium battery wiring	36
3.14 Smart Meter measurement connection method for system	39
3.15 Inverter Remote Monitoring Connection	40
4. Overview	41-41
4.1 Intelligent LED Indicators	41
4.2 Password Reset	41
4.3 Inverter built-in Bluetooth description	41
5. Commissioning	42-53
5.1 Pre-Commissioning	42
5.2 Power ON	42
5.3 Power OFF	42
5.4 HMI Screen Setting	43
5.5 APP Setting	53
6. Maintenance	75
6.1 Smart O&M	75
7. Troubleshooting	76
8. Specifications	81

1.1 Product Overview

The Solis series is designed for commercial hybrid systems.

The inverter can work with maximize self-consumption and provide backup power if the grid fails and there is not enough PV power to cover load demand.

The Solis S6 series consists of the following inverter models:

29.9kW,30kW,40kW,50kW

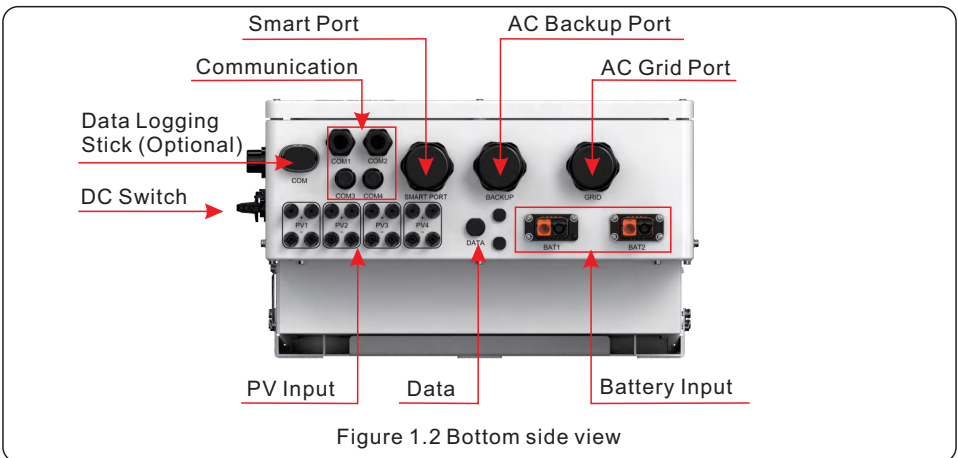
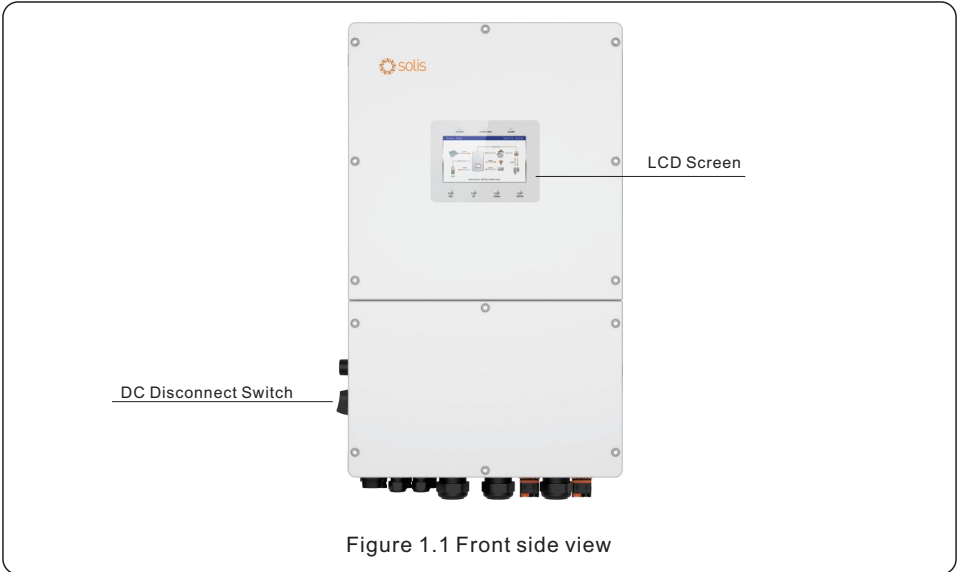

1.2 Inverter Wire Box and Connection Points

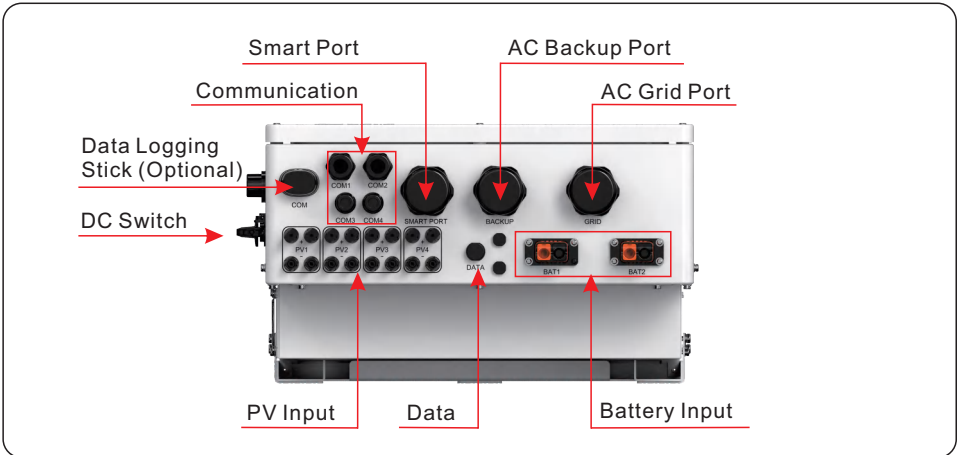

Name	Description
1. DC Switch	This is the DC disconnect switch for the PV
2. COM	Solis data logger gets connected here-only USB version of the loggers will work
3. COM1	RS485 and CAN communication cables and parallel cables should go through these
4. COM2	RS485 and CAN communication cables and parallel cables should go through these
5. COM3	Communication cables for 14PIN terminal block should go through these
6. COM4	Communication cables for 14PIN terminal block should go through these
7. Smart Port	Conduit for AC conductors to generator should be connected here
8. Backup	Conduit for AC conductors to backup loads panel should be connected here
9. Grid	Conduit for AC conductors to the main service panel should be connected here
10. PV Module Input	Conduit for PV conductors should be connected here
11. Battery Connection	Conduit for Battery conductors should be connected here
12. DATA	Extends the range of the inverter GPRS signal (Not applicable to the USA, Australia, Europe)

1.3 Product Features

Outstanding Performance

- Support dual batteries up to 70+70A/140A max charge/discharge current, flexible battery configuration for customers on site.
- Integrated 4 MPPTs and string current up to 20A, suitable for both 182mm and 210mm PV modules.
- Support 1.6times rated power as peak power output on Backup port to ensure crucial loads uninterrupted operation during the switch of on and off grid, especially for air-conditioner, water pump, motor, etc.
- Support 100% imbalance power of each phase on Backup port to ensure power supply for different scenarios of loads.
- Max. 6 pcs parallel for on-grid and off-grid operation, scalable capacity satisfying more kinds of customer needs.
- Compatible with batteries from multiple famous brands and support wide voltage range giving customers multiple battery options.
- Lighter weight 73kg among similar 50k products, convenient for installation and maintenance.

Intelligent Function

- Support peak shaving control in both grid and generator condition.
- Generator connectivity with multiple input methods and automatic generator On/Off control.
- UPS level switching time (<10ms) supporting critical loads all the time.
- 99% High PV charge efficiency to prevent excess PV loss.
- 6 customizable charge/discharge time settings to gain more revenue from customer side.
- Multiple working modes to meet different use case scenarios.
- Controllable and Upgradeable via the SolisCloud App to avoid site visits.

Safe&Reliable

- Safety protection with integrated AFCI function, which actively detects arc faults in the PV Array.
- Multiple battery protection function.

1.4 Packaging

Please ensure that the following items are included in the packaging with your machine:

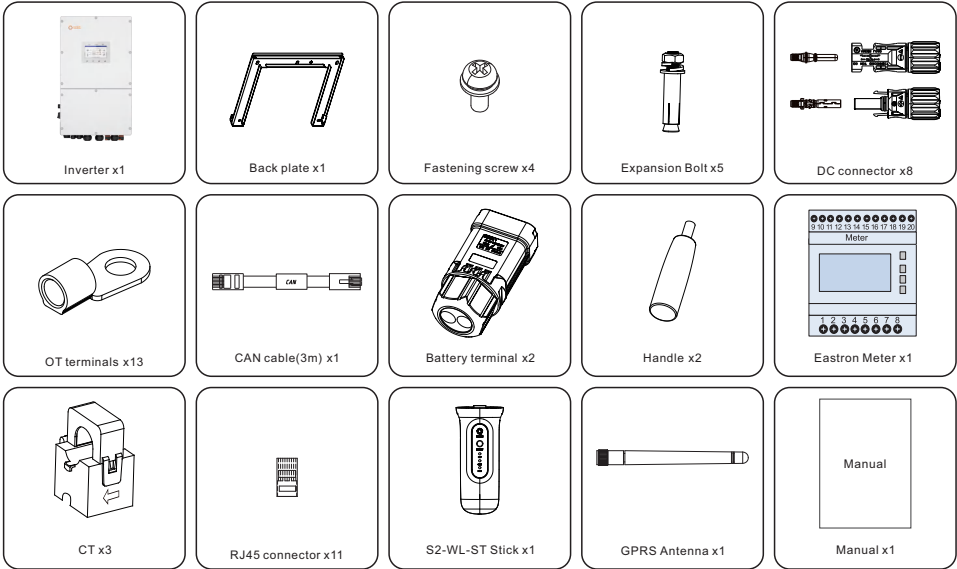

If anything is missing, please contact your local Solis distributor.



NOTE

CT default Length : 4m, and the its extension not supported.

1.5 Tools Required for Installation



2.1 Safety

The following types of safety instructions and general information appear in this document as described below:



DANGER

“Danger” indicates a hazardous situation which if not avoided, will result in death or serious injury.



WARNING

“Warning” indicates a hazardous situation which if not avoided, could result in death or serious injury.



CAUTION

“Caution” indicates a hazardous situation which if not avoided, could result in minor or moderate injury.



NOTE

“Note” provides tips that are valuable for the optimal operation of your product.



WARNING: Risk of fire

Despite careful construction, electrical devices can cause fires.

- Do not install the inverter in an area containing flammable materials or gases.
- Do not install the inverter in a potentially explosive atmosphere.

2.2 General Safety Instructions



WARNING

Only devices in compliance with SELV (EN 69050) may be connected to the RS485 and USB interfaces.



WARNING

Do not connect PV array positive (+) or negative (-) to ground, doing so could cause serious damage to the inverter.



WARNING

Electrical installations must be done in accordance with local and national electrical safety standards.



WARNING

Do not touch any internal parts until 5 minutes after disconnection from the utility grid, PV array, and battery.



WARNING

To reduce the risk of fire, over-current protective devices (OCPD) are required for all circuits connected to the inverter.

The DC OCPD shall be installed per local requirements. All photovoltaic source and output circuit conductors shall have isolators that comply with the NEC Article 690, Part II.

All Solis single phase inverters feature an integrated DC disconnect switch.



CAUTION

Risk of electric shock, do not remove the cover. There are no serviceable parts inside, refer servicing to qualified and accredited service technicians.



CAUTION

The PV conductors are energized with high voltage DC when the PV modules are exposed to sunlight.



CAUTION

The surface temperature of the inverter can reach up to 75°C.

To avoid risk of burns, do not touch the surface of the inverter while it is operating. The inverter must be installed out of direct sunlight exposure.



NOTE

PV modules used with inverter must have an IEC 61730 Class A rating.



WARNING

Operations must be accomplished by a licensed electrician or a person authorized by Solis.



WARNING

Installer must wear personal protective equipment during the entire installation process in case of electrical hazards.



WARNING

The AC Backup Port of the inverter cannot be connected to the grid.



WARNING

Please refer to the product manual of the battery before installation and configuration to the inverter.



Systems using this product shall be designed and built in accordance with the NEC & local electrical codes & standards.



NOTE

Please Notice that Max.operation altitude 4000m, but Max. input PV voltage will derate when above 2000m, the following table shows the relationship between elevation and voltage.

Elevation (m)	Voltage (Vdc)
2000	1000
2700	1000
3000	981
3500	925
4000	875

2.3 Notice for Use

The inverter has been constructed according to the applicable safety and technical guidelines, use the inverter in installations that meet the following specifications only:

1. Permanent installation is required.
2. The electrical installation must be compliant with all local and national regulations & standards.
3. The inverter must be installed according to the instructions stated in this manual.
4. The inverter must be installed according to the inverter technical specifications.

2.4 Notice for Disposal

This product shall not be disposed as household waste.

It must be segregated and brought to an appropriate disposal facility to ensure proper recycling.

This is to be done in order to avoid negative impacts on the environment and human health.

Local waste management rules shall be observed and respected.



2.5 Notice for Transportation

For the transportation demands of integrating with battery or install inverter in container, solis only support separate transport, and the battery pack should be placed in the freight cabinet follow the battery manufacturer's rule, and the inverter should be placed on its own tray, we also dont support the machine is transported in the cabinet in the form of back-hanging.

3.1 Select a Location to Install the Inverter

When selecting a location for the inverter, the following criteria should be considered:

- Exposure to direct sunlight may cause output power derating due to overheating. It is recommended to avoid installing the inverter in direct sunlight. The ideal location is one where the ambient temperature does not exceed 40°C.
- It is also recommended to install the inverter somewhere the rain and snow will not land directly on it. The ideal installation location is on a north-facing wall under an eave.

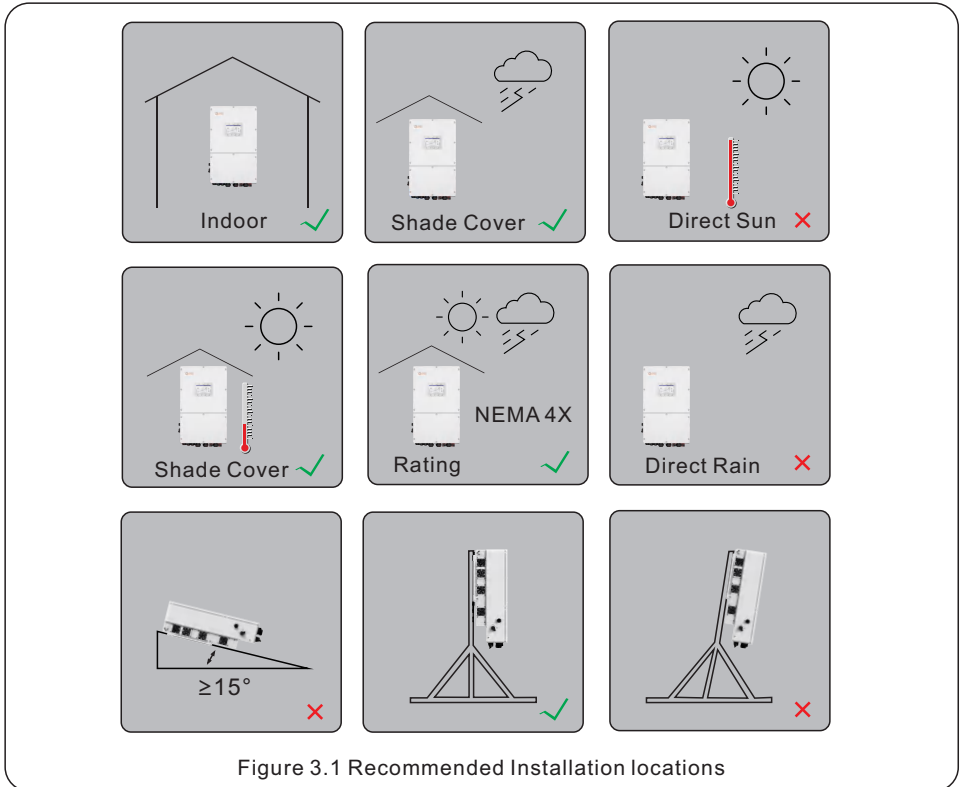

WARNING: Risk of fire



Despite careful construction, electrical devices can cause fires.

- Do not install the inverter in areas containing highly flammable materials or gases.
- Do not install the inverter in potentially explosive atmospheres.
- The mounting structure where the inverter is installed must be fireproof.

When selecting a location for the inverter, consider the following:



CAUTION: Hot Surface

- The temperature of the inverter heat-sink can reach 75°C.

The ambient temperature and relative humidity of the installation environment should meet the following requirements:

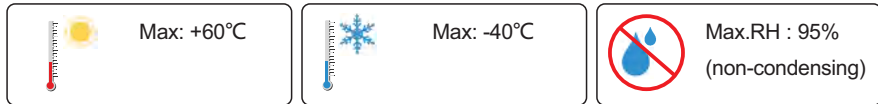

Figure 3.2 Installation environment conditions



Load bearing surface:

Made of non-inflammable materials

Max. load bearing capacity \geq 4 times of inverter weight

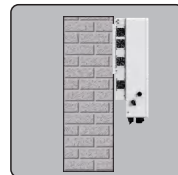

3.1.1 Clearances

- If multiple inverters are installed on site, a minimum clearance of 500mm should be kept between each inverter and all other mounted equipment. The bottom of the inverter should be at least 1000mm above of the ground or floor.
- The LED status indicator lights located on the inverter's front panel should not be blocked
- Adequate ventilation must be present if the inverter is to be installed in a confined space.

3.1.2 Consult technical data

- Consult the technical specifications sections at the end of this manual for additional environmental condition requirements (temperature range, altitude, etc.)

3.1.3 Angle of installation

- This model of Solis inverter must be mounted vertically (90 degrees or backwards less than or equal to 15 degrees from 90 degrees straight up).

3.1.4 Avoiding direct sunlight

Installation of the inverter in a location exposed to direct sunlight should to be avoided.

Direct exposure to sunlight could cause:

- Power output limitation (with a resulting decreased energy production by the system).
- Premature wear of the electrical/electromechanical components.
- Premature wear of the mechanical components (gaskets) and user interface.

3.1.5 Air circulation

Do not install in small, closed rooms where air cannot freely circulate.

To prevent overheating, always ensure that the air flow around the inverter is not blocked.

3.1.6 Flammable substances

Do not install near flammable substances. Maintain a minimum distance of three meters (10 feet) from such substances.

3.1.7 Living area

Do not install in a living area where the prolonged presence of people or animals is expected. Depending on where the inverter is installed (for example: the type of surface around the inverter, the general properties of the room, etc.) and the quality of the electricity supply, the sound level from the inverter can be quite high.

3.2 Product Handling

Please review the instruction below for handling the inverter:

1. The red circles below denote cutouts on the product package - one per side.
Push in the cutouts to form handles for moving the inverter (see Figure 3.3).
2. Two people are required to remove the inverter from the shipping box. Use the handles integrated into the heat sink to remove the inverter from the carton.
3. When setting the inverter down, do it slowly and gently. This ensures that the internal components and the outer chassis do not take any damage.
4. There are two black mounting handrails on the machine, they are removable and convenient for installation (see Figure 3.4).
5. The position of handrails installation as the red mark in figure 3.4.

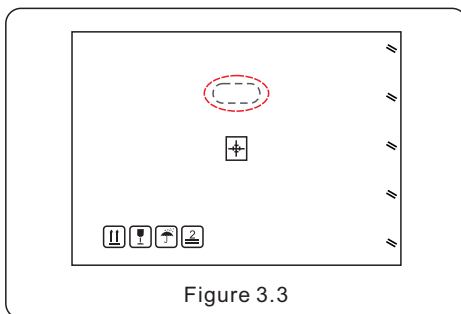

Figure 3.3

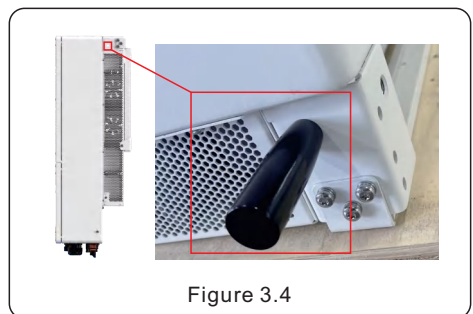

Figure 3.4

3.3 Mounting the Inverter

- Mount the inverter on a wall or structure capable of bearing the weight of the machine.
- The inverter must be mounted vertically with a maximum incline of +/- 5 degree. Exceeding this may cause the output power to derate.
- To avoid overheating, always make sure the flow of air around the inverter is not blocked. A minimum clearance of 500mm should be kept between inverters or objects and 1000mm clearance between the bottom of the machine and the ground.



Figure 3.5 Inverter Mounting Clearances

- Visibility of the LED indicator lights should be considered.
- Adequate ventilation around the inverter must be provided.



NOTE

Nothing should be stored on the top of or placed against the inverter.

Dimensions of mounting bracket:

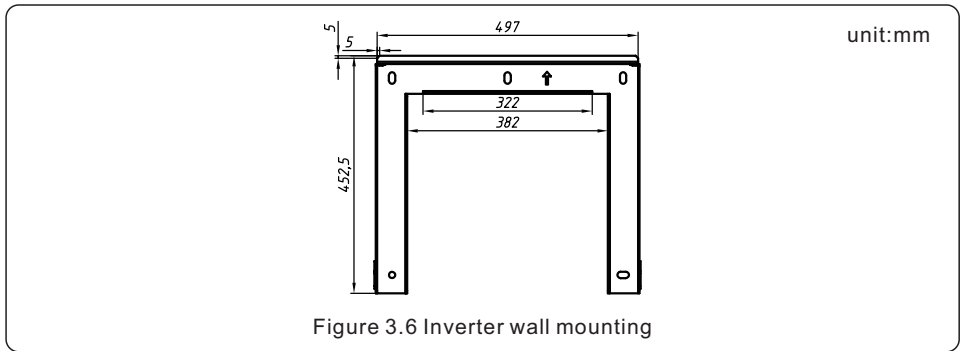

Once a suitable location has been found according to 3.1 using figure 3.6 mount the wall bracket to the wall.

The inverter shall be mounted vertically.

The steps to mount the inverter are listed as below:

1. Select the mounting height of the bracket and mark the mounting holes.
For brick walls, the position of the holes should be suitable for the expansion bolts.
2. Lift up the inverter (be careful to avoid body strain), and align the back bracket on the inverter with the convex section of the mounting bracket. Hang the inverter on the mounting bracket and make sure the inverter is secure (see Figure 3.7)

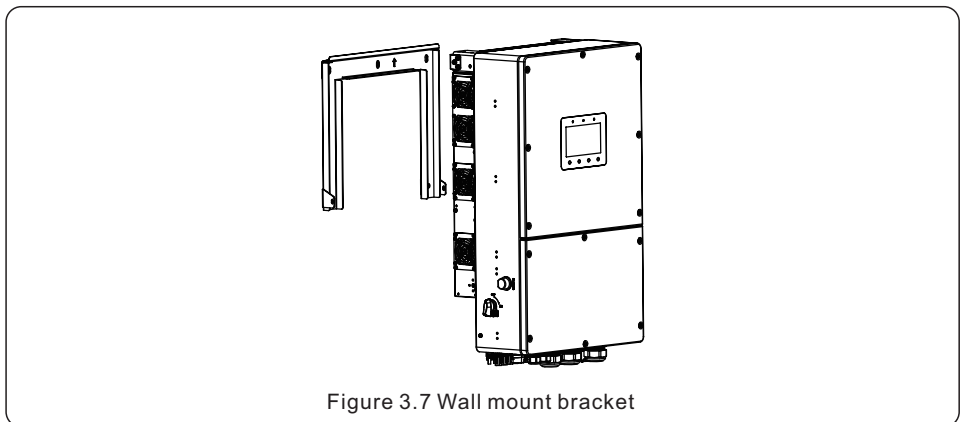

WARNING:

The inverter must be mounted vertically.

3.4 Inverter Wiring Overview

	Purpose	Connection Points
PV Cables	PV DC connection to the inverter	From the PV array to the DC+ and DC- terminals in the inverter
Battery Cables	Battery DC connection to the inverter	From the battery (+) and (-) terminals to the inverter BAT+ and BAT- terminals
AC Grid Cables	Inverter AC connection to the main service panel	From the OCPD in the main service panel to the AC-GRID L1, L2, L3 terminals
AC Backup Cables	Inverter AC connection to the backup subpanel	From the backup loads subpanel OCPD to the inverter AC-BACKUP L1, L2, L3 terminals
Ground Cables	Grounding conductors for the system	From the main service panel ground bar to the ground bar inside the inverter wire box
Meter cable	Communication between inverter & Meter	From meter to terminal HM. For more details, refer to figure Installing the energy meter
Battery communication cable	Communication between the inverter & the battery	From battery to terminal BMS. For more details, refer to figure Installing the battery
Data Logger (Optional)	Monitoring of the system on SolisCloud	USB COM port at the bottom of the inverter (For more details, please refer to the Solis data logger product manual)



NOTE

Conductor dimensions and OCPD sizing to be determined in accordance with the national electrical code (NEC) and local standards.

3.5 Ground Cable Installation

An external ground connection is provided at the both sides of inverter.

Prepare OT terminals: M5. Use proper tooling to crimp the lug to the terminal.

Connect the OT terminal with ground cable to the right side of inverter. The torque is 3.5N.m.

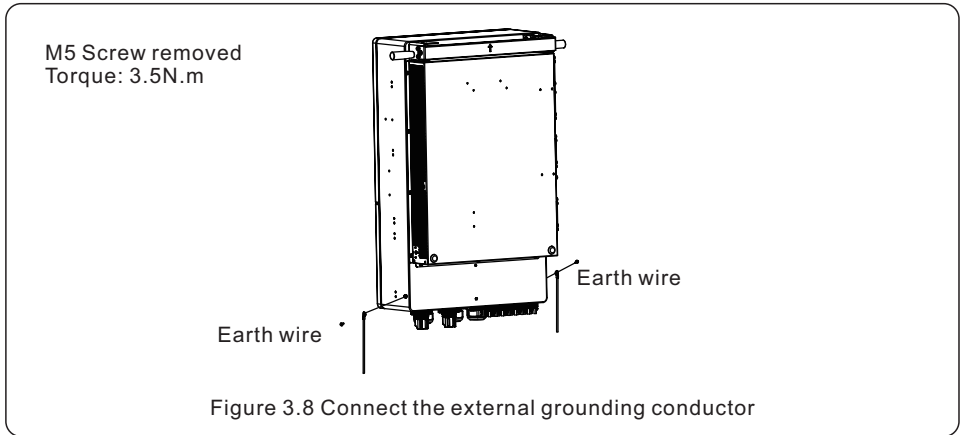

To connect the grounding terminal on the heat sink, please follow the steps below:

1. It is recommended to use copper wire for the chassis ground. Either solid conductor or stranded wire is acceptable. Refer to local code standard for wire sizing.
2. Attach OT terminal: M5.



IMPORTANT

For multiple inverters in parallel, all inverters should be connected to the same ground point to eliminate the possibility of a voltage potential existing between inverter grounds.

3. Strip the ground cable insulation to a suitable length. (see Figure 3.9)
4. Crimp a ring connector onto the cable and then connect it to the chassis ground terminal.

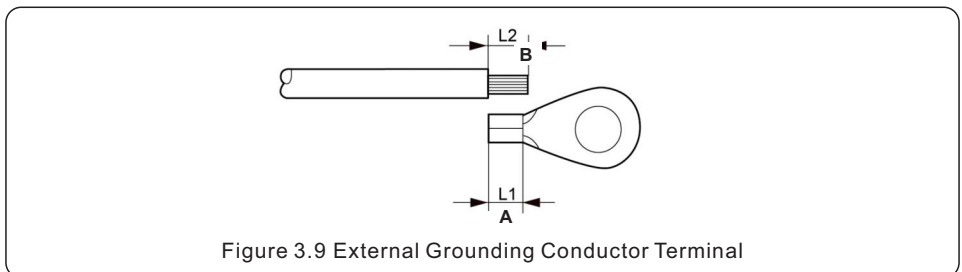

3.6 PV Cable Installation



Before connecting inverter, please make sure the PV array open circuit voltage is within the limit of the inverter.



Before connection, please make sure the polarity of the output voltage of PV array matches the "DC+" and "DC-" symbols.



Please use approved DC cable for PV system.

A DC-PV1 switch, complied to AS60947.3:2018, within the inverter, is used as isolating device. Please check below ratings.

DC switch brand	SVRU(TIANJIN)ELECTRICAL EQUIPMENT CO.LTD
Model	GHX6-55P/8P1100-45-2-O-F
PV category	DC-PV2
Ue	1100V
Ie	45A
Ui	1500V
Uimp	8000V
Icw	1500A
Icm	2000A
I(make)/Ic(break)	180A
Complied standard	AS 60947.3:2018, ASINZS IEC 60947.1:2015

1. Select a suitable DC cable and strip the wires out by $7\pm 0.5\text{mm}$. Please refer to the table below for specific specifications.

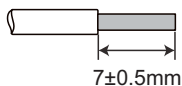

Cable type	Cross section (mm ²)	
	Range	Recommended value
Industry generic PV cable	4.0~6.0 (12~10AWG)	4.0 (12AWG)

Figure 3.10

2. Take the DC terminal out of the accessory bag, turn the screw cap to disassemble it, and take out the waterproof rubber ring.

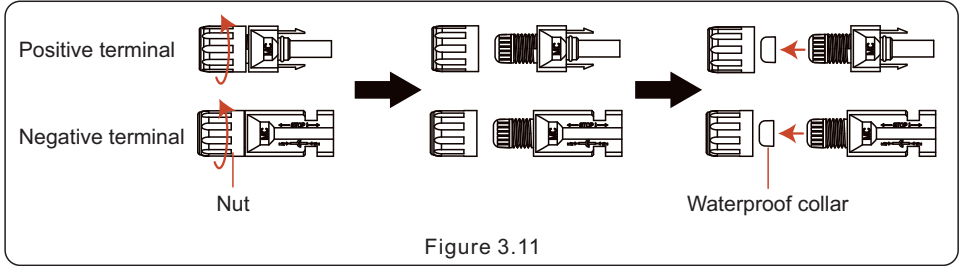

3. Pass the stripped DC cable through the nut and waterproof rubber ring.

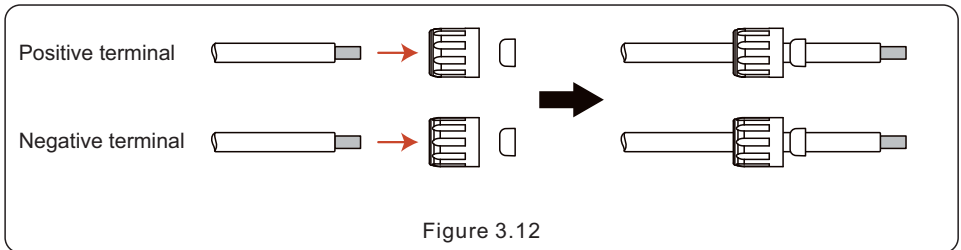

4. Connect the wire part of the DC cable to the metal DC terminal and crimp it with a special DC terminal crimping tool.

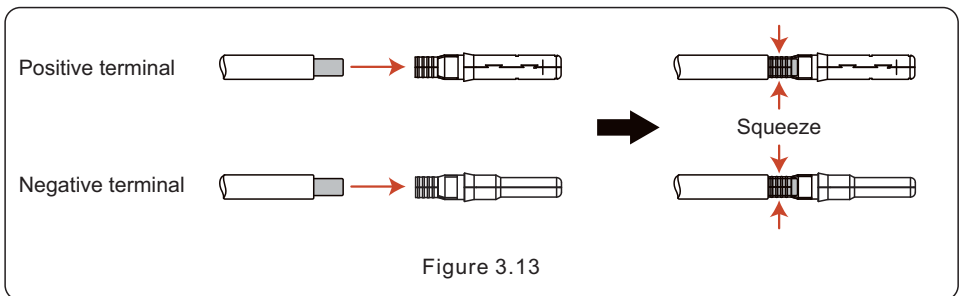

5. Insert the crimped DC cable into the DC terminal firmly, then insert the waterproof rubber ring into the DC terminal and tighten the nut.

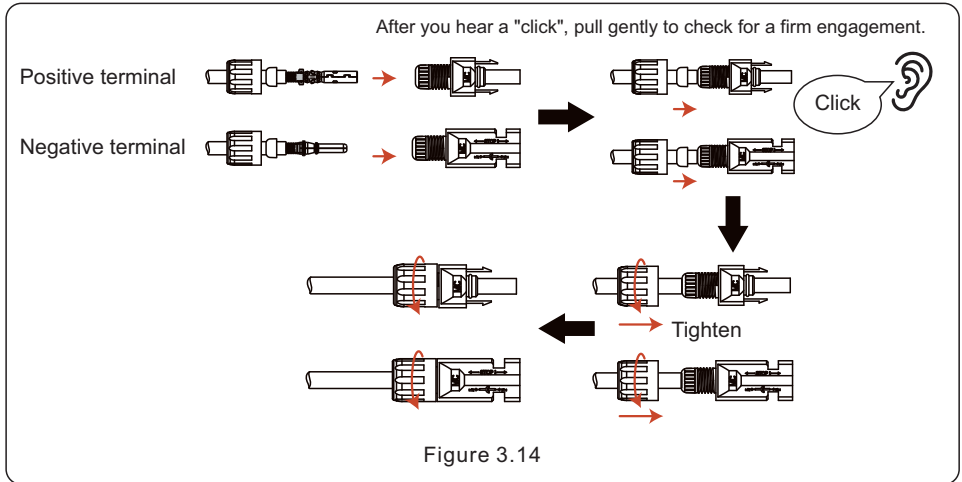

6. Measure PV voltage of DC input with multimeter, verify DC input cable polarity.

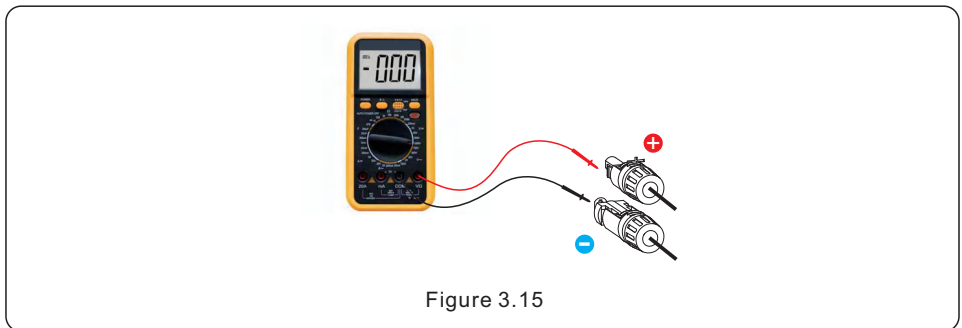

7. Connect the wired DC terminal to the inverter as shown in the figure, and a slight "click" is heard to prove the connection is correct.

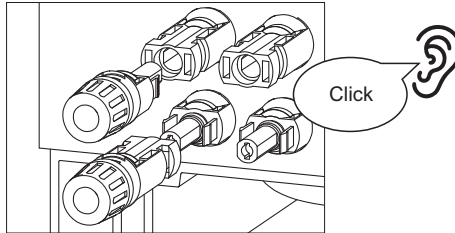

Figure 3.16



CAUTION:

If DC inputs are accidentally reversely connected or inverter is faulty or not working properly, it is NOT allowed to turn off the DC switch. Otherwise it may cause DC arc and damage the inverter or even lead to a fire disaster. The correct actions are:

*Use a clip-on ammeter to measure the DC string current.

*If it is above 0.5A, please wait for the solar irradiance reduces until the current decreases to below 0.5A.

*Only after the current is below 0.5A, you are allowed to turn off the DC switches and disconnect the PV strings.

* In order to completely eliminate the possibility of failure, please disconnect the PV strings after turning off the DC switch to avoid secondary failures due to continuous PV energy on the next day.

Please note that any damages due to wrong operations are not covered in the device warranty.

3.7 Battery Cable Installation



DANGER

Before installing the battery cables, be sure that the battery is turned off. Use a multimeter to verify that the battery voltage is 0Vdc before proceeding. Consult the battery product manual for instructions on how to turn it off.



NOTE

The battery fuse in the inverter wire box is replaceable. But only replaced by authorization of Solis.
 BAT fuse1 and fuse2 specification are 1000V 100A.
 The suggested specification of external BAT circuit breaker for each battery is 80A.

3.7.1 Installation Steps

Dimension of stripping line inside machine

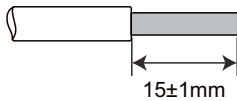

Cable type	Cross section (mm ²)
Battery cable	10.0~25.0 MAX

Dimension of stripping line outside machine

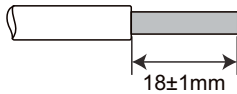

Cable type	Cross section (mm ²)
Battery cable	10.0~25.0 MAX

1. Insert the cable into the rubber core according to the line sequence, observe the perspective hole, the cable is in place, and the torque of the crimping screwdriver is 4 ± 0.1 N. M.

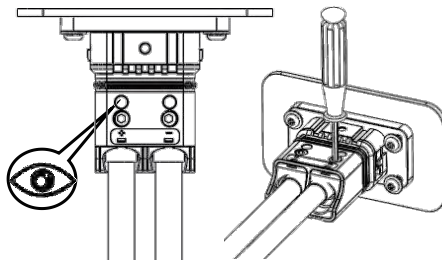

2. Insert the main body into the rubber core and hear the "click" sound.

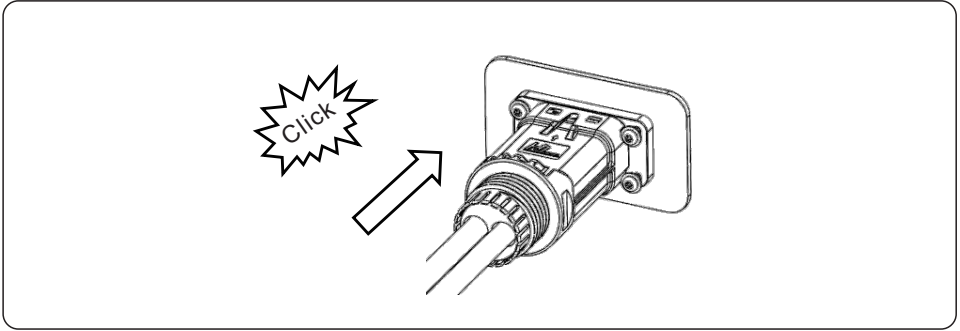

3. Complete the installation.

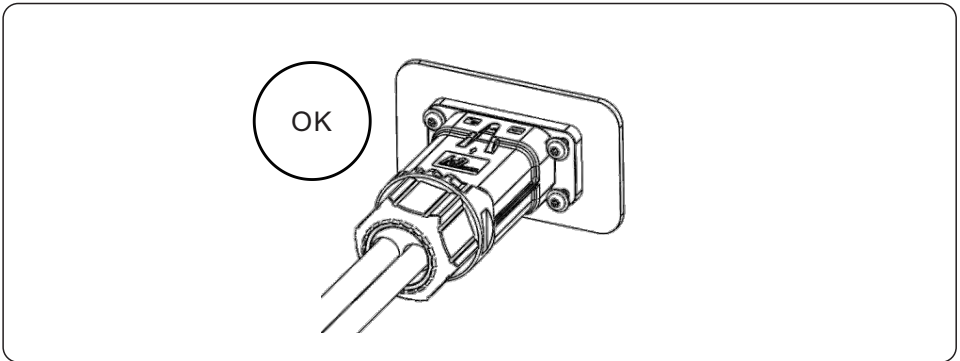

3.7.2 Disassembly Steps

1. Use a screwdriver to align the unlocking position, press and hold the main body and pull back to complete the removal.

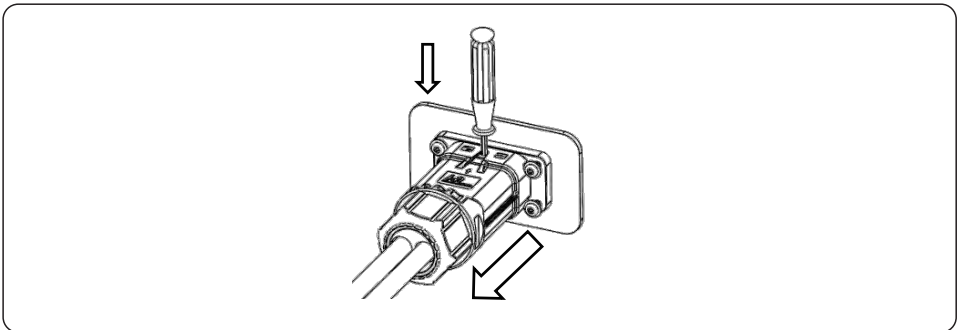

3.8 AC Wiring



DANGER

Before installing the AC cables, be sure that the OCPDs (breakers) are turned off.

Use a multimeter to verify that the AC voltages are 0Vac before proceeding.

There are three sets of AC output terminals and the installation steps for both are the same. The maximum temperature for connecting AC and battery terminals is 85°C.

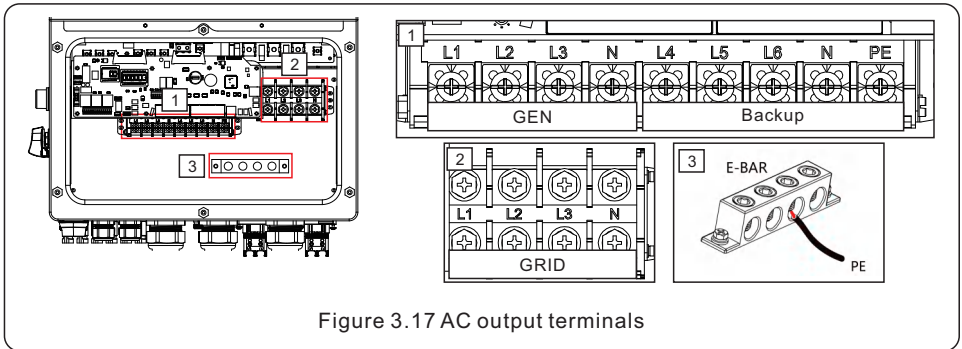

Figure 3.17 AC output terminals

Model	Smart port	Backup port	Grid port	Earth Bar
Wire Size	3AWG/4AWG	3AWG/4AWG	0AWG/1AWG	2 AWG
Torque	28.2 N.m			20.3 N.m
Cable	16 mm2/16 mm2/50 mm2			25 mm2

1. Bring the AC cables for the backup loads panel (backup) and the main service panel (grid) into the inverter wire box. The backup loads panel should not be electrically connected to the main service panel.
2. Strip 13mm from the ends of each cable. Crimp the R-type connectors onto the ends.
3. Remove the terminal bolts, insert them into the connectors, then use a torque wrench to tighten the bolts down.
4. Please refer to the terminal labels to connect the AC wires to the correct terminals.

Cable Gland are recommended torque for installation is 7-7.5 N.m. In order to ensure waterproof effect, the operator regularly checks whether the installation is tight.

3.9 CT Connection



CAUTION:

Make sure the AC cable is totally isolated from AC power before connecting the or CT.

3.9.1 CT Installation

The CT provided in the product box is compulsory for hybrid system installation. It can be used to detect the grid current direction and provide the system operating condition to hybrid inverter.

CT Model: ESCT-TA24

CT Cable: Size – 2.3mm², Length - 4m, its extension not supported.

Please install the CT on the hot line at the system grid connection point and the arrow on the CT needs to point to the grid direction.

Lead the CT wires through the COM3 port at the bottom of the inverter and connect the CT wires to the 14pin communication terminal block.

CT Wire	14 PIN Communication Terminal Block
White	Pin 1 (From Left to Right)
Black	Pin 2 (From Left to Right)
White	Pin 3 (From Left to Right)
Black	Pin 4 (From Left to Right)
White	Pin 5 (From Left to Right)
Black	Pin 6 (From Left to Right)

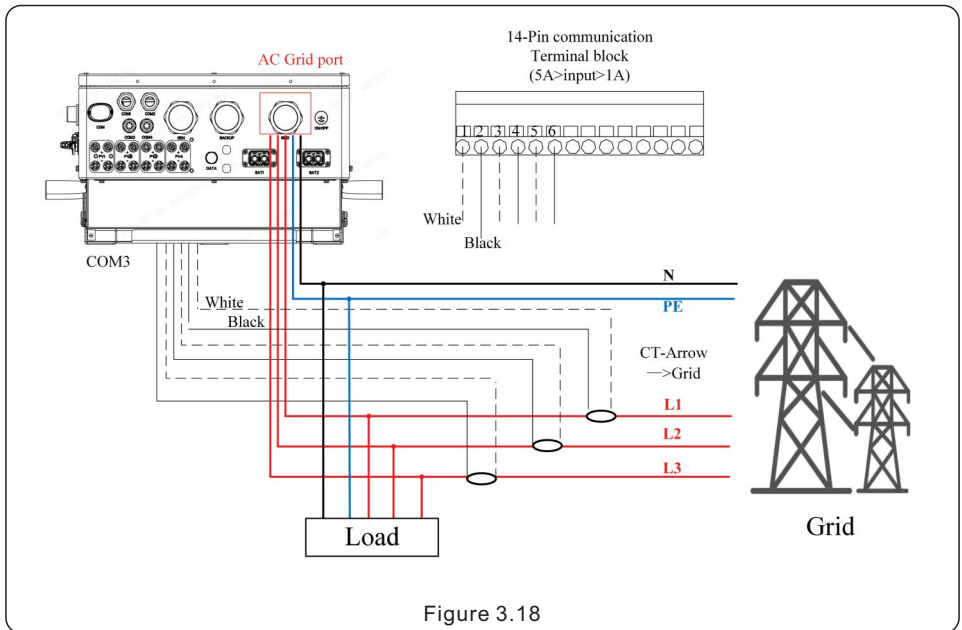

Figure 3.18

N line connection:

The system support N lines connected to the inverter N line terminal on the inverter individually.

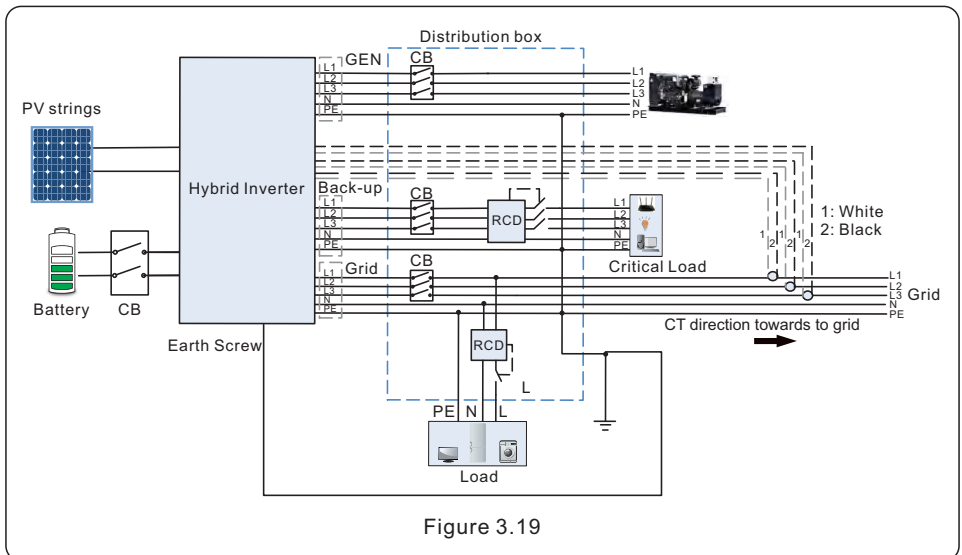
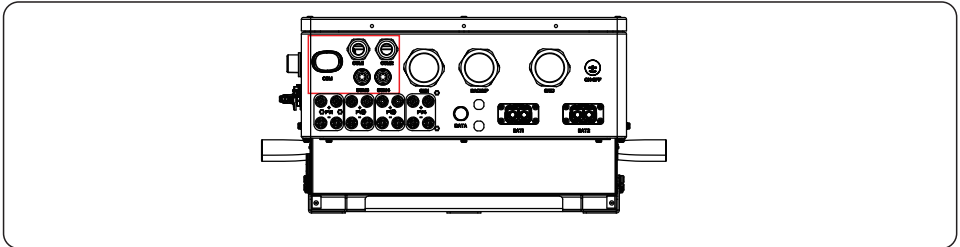

Figure 3.19

3.10 Inverter Communication

3.10.1 Communication Ports



Port	Port Type	Description
COM	USB	Used for Solis data logger connection
COM1	4 hole watertight cable gland	Used for RJ45 connection inside wiring box
COM2	4 hole watertight cable gland	Used for RJ45 connection inside wiring box
COM3	6 hole watertight cable gland	Used for 14 PIN terminal block connection inside wiring box
COM4	6 hole watertight cable gland	Used for 14 PIN terminal block connection inside wiring box

Wiring steps for COM1-COM4:

Step 1. Loose the cable gland and remove the watertight caps inside the cable gland based on the number of the cables and keep the unused holes with watertight cap.

Step 2. Lead the cable into the holes in the cable gland.

(COM1-COM2 Hole Diameter: 6mm, COM3-COM4 Hole Diameter: 2mm)

Step 3. Connect the cable to the corresponding terminals inside the wiring box.

Step 4. Reassemble the cable gland and ensure there is no bending or stretching of the cables inside the wiring box.



NOTE:

The 4-hole fastening rings inside the cable gland for COM1 and COM2 are with openings on the side.

Please separate the gap with hand and squeeze the cables into the holes from the side openings.

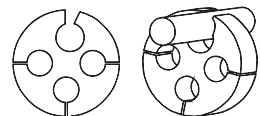

3.10.2 Communication Terminals

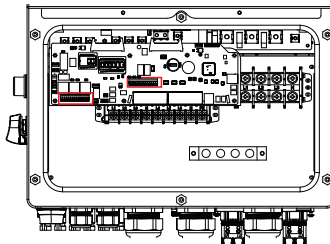

Figure 3.20 Communication terminals

Terminal	Type	Description
BMS	RJ45	Used for CAN communication between inverter and Lithium battery BMS.
Meter	RJ45	(Optional)Used for RS485 communication between inverter and the smart meter.
DRM	RJ45	(Optional) To realize Demand Response or Logic Interface function, this function may be required in UK and Australia.
EMS	RJ45	Used for 3rd party external device or controller by RS485 communication protocol.
P-A	RJ45	(Optional) Parallel operation communication port.
P-B	RJ45	(Optional) Parallel operation communication port.
DIP Switch (2-1)	-	If the parallel machine is connected to the first and last consoles of the parallel connection, you need to put the DIP switch on the ARM board to ON, and the middle machine is all OFF.
HM	Terminal Block	Pin 1 & Pin 6 (From Left to Right) Used for CT wire connection.
G-V	Terminal Block	Pin 7 & Pin 8 (From Left to Right) Used for Generator start-stop signal.
G-S	Terminal Block	Pin 9 & Pin 10 (From Left to Right)Reserved.
ATS380V	Terminal Block	Pin13 (L) Pin14(N) (From Left to Right)380V ATS signal.

3.10.3 BMS Terminal Connection

3.10.3.1 With Lithium Battery

CAN communication is supported between inverter and compatible battery models. Please lead the CAN cable through the COM1 or COM2 port of the inverter and connect to the BMS terminal with RJ45 connector.

Inverters of this series type support that customers using the batteries with different capacity and with different specification, but Solis recommend that using the batteries with same specification is better for the whole inverter system work excellently.

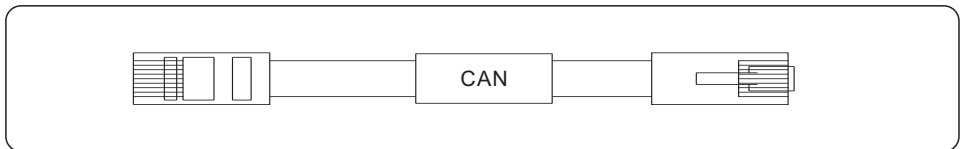

NOTE:



Before connecting CAN cable with the battery, please check whether the communication pin sequence of the inverter and the battery match; If it does not match, you need to cut off the RJ45 connector at one end of the CAN cable and adjust the pin sequence according to the pin definitions of both inverter and battery.

Pin definition of the inverter BMS Port is following EIA/TIA 568B.

CAN-H on Pin 4: Blue

CAN-L on Pin 5: Blue/White

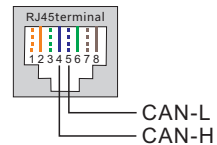

NOTE:



Before connecting RS485 cable with the battery, please check whether the communication pin sequence of the inverter and the battery match; If it does not match, you need to cut off the RJ45 connector at one end of the RS485 cable and adjust the pin sequence according to the pin definitions of both inverter and battery.

Pin definition of the inverter BMS Port is following EIA/TIA 568B.

RS485A on Pin 6: Green

RS485B on Pin 3: Green/White

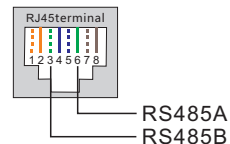

3.10.4 Meter Terminal Connection (Optional)

If a smart meter is preferred to be installed other than the provided CT, please contact Solis sales rep to order the smart meter and corresponding meter CT.

Please lead the Meter RS485 cable through the COM1 or COM2 port of the inverter and connect to the Meter terminal with RJ45 connector.

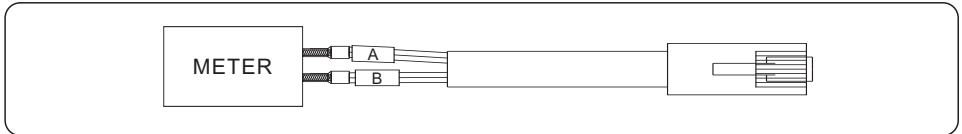

NOTE:

Pin definition of the Meter Terminal is following EIA/TIA 568B.

- RS485A on Pin 1: Orange/white
- RS485B on Pin 2: Orange

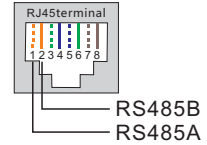

3.10.5 DRM Port Connection (Optional)

3.10.5.1 For Remote Shutdown Function

Solis inverters support remote shutdown function to remotely control the inverter to power on and off through logic signals.

The DRM port is provided with an RJ45 terminal and its Pin5 and Pin6 can be used for remote shutdown function.

Signal	Function
Short Pin5 and Pin6	Inverter Generates
Open Pin5 and Pin6	Inverter Shutdown in 5s

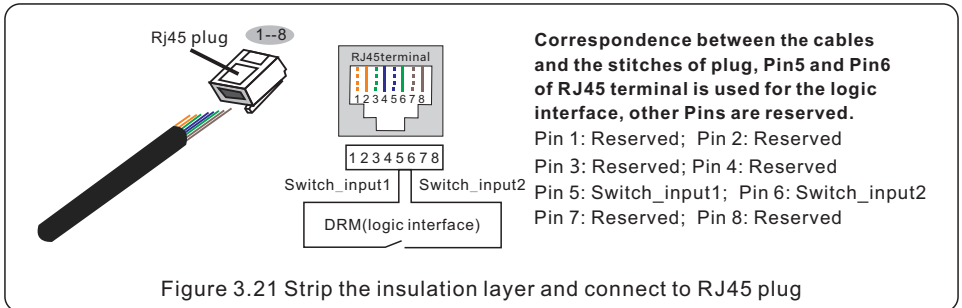

3.10.5.2 For DRED Control Function (For AU and NZ Only)

DRED means demand response enable device. The AS/NZS 4777.2:2020 Inc A1 required inverter need to support demand response mode(DRM).

This function is for inverter that comply with AS/NZS 4777.2:2020 Inc A1 standard.

A RJ45 terminal is used for DRM connection.

Pin	Assignment for inverters capable of both charging and discharging	Pin	Assignment for inverters capable of both charging and discharging
1	DRM 1/5	5	RefGen
2	DRM 2/6	6	Com/DRM0
3	DRM 3/7	7	V+
4	DRM 4/8	8	V-



NOTE:

Solis hybrid inverter is designed to provide 12V power for DRED.

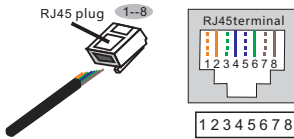

Correspondence between the cables and the stitches of plug

- Pin 1: white and orange ; Pin 2: orange
- Pin 3: white and green; Pin 4: blue
- Pin 5: white and blue; Pin 6: green
- Pin 7: white and brown; Pin 8: brown

Figure 3.22 Strip the insulation layer and connect to RJ45 plug

3.10.6 RS485 Port Connection (Optional)

This port only supports RS485 communication protocol, and it can be used as a master controller port to control the other equipment, such as: on-gird inverter, if you need the communication protocol document, please contact the Solis local service team or Solis sales to get the latest version.



NOTE:

Pin definition of the RS485 Port is following EIA/TIA 568B.

- RS485A on Pin 5: Blue/White
- RS485B on Pin 4: Blue

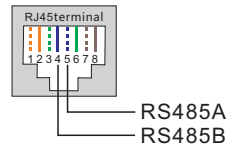

3.10.7 Parallel Inverter Connection (Optional)

Up to 6 units of the inverter can be connected in parallel.

Please connect the paralleled inverters by using P-A and P-B terminals. Standard CAT5 with shielding layers internet cable can be used.

1. ALL inverter MUST be connected to their own HV battery.
2. NOT support two or more inverters connect to the same one battery.

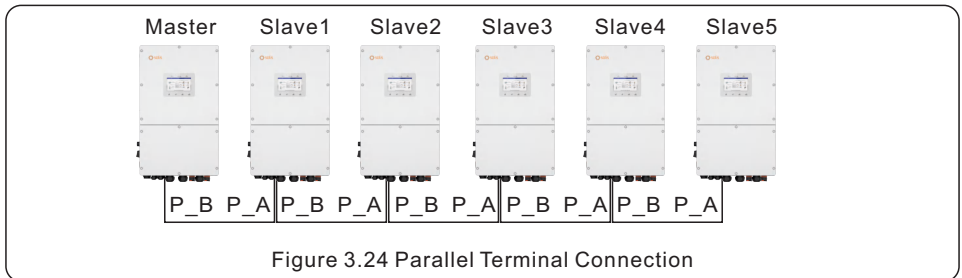
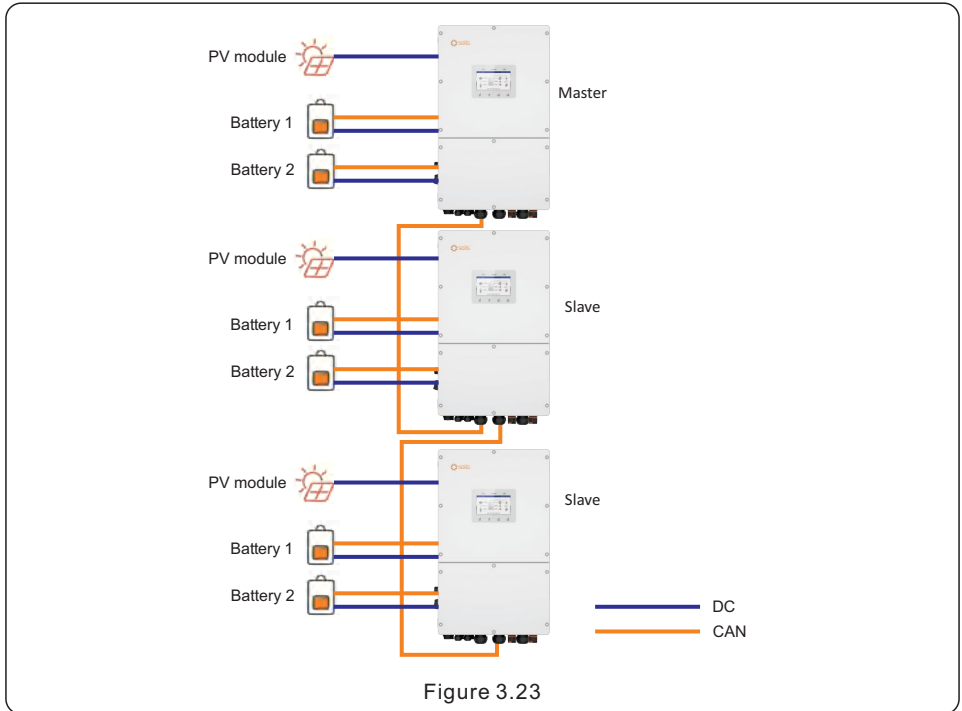



NOTE:

If the parallel machine is connected to the first and last consoles of the parallel connection, you need to put the DIP switch on the ARM board to ON, and the middle machine is all OFF.

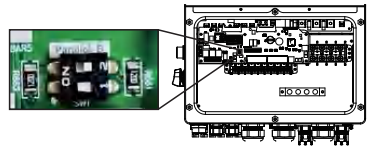

NOTE:

The parallel communication cable should be standard STP(Shielded Twisted Pair)CAT5 network cable, currently supports cable length 3~5m between two machine, Sometimes, if the customer wants to increase the distance between two or more parallel machines, Solis supports 2 pcs in parallel mode, the distance between the first and last machines is 20m, and for 6 pcs in parallel mode, the distance between the first and last machine is 50m, the communication is normal. If you have other demands about the communication cable length, please contact the solis official technical-support staff.



NOTE:

If you want to do the parallel communication by your own parallel cable instead of the cable in accessory, you should use the shielding cable and keep the wire sequence as: Orange white, orange, green white, green, blue, white blue, white brown, brown.



NOTE:

Single inverter noise is less than 65 dB(A), When using multiple inverters to combine, pay attention to noise protection.

3.10.8 14-pin Communication Terminal Block

Terminal Block Connection Steps:

Step 1. Lead the wires through the hole in COM3 port (Hole Diameter: 2 mm)

Step 2. Strip the wires for 9mm length

Step 3. Use slot type screwdriver to press the block on the top

Step 4. Insert the exposed copper part of the cable into the terminal.

Step 5. Remove the screwdriver and the terminal will clamp down on the exposed copper part.

Step 6. Give the cable a gentle tug to ensure that it is firmly secured.

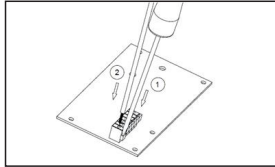

3.10.8.1 HM Terminal Connection (CT Terminal Connection)

CT connection is necessary to realize the correct control logic of the hybrid inverter, unless the smart meter is used as stated in section 3.10.4 and section 3.9.

The CT provided in the inverter package has BLACK(S2) and WHITE(S1) wires. The BLACK wire needs to connect to the Pin 2, Pin 4, Pin6 of the terminal block and the WHITE wire needs to connect to the Pin 1, Pin3, Pin5 of the terminal block as in the following diagram.



NOTE:

The voltage accuracy of the machine is 0.5%, and the CT current accuracy is 0.5%, so the total accuracy of inverter is 1%(voltage + current).

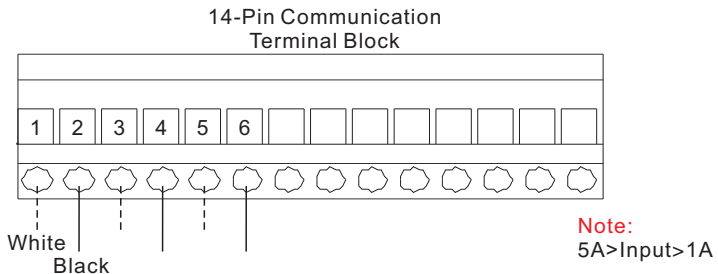

3.10.8.2 G-V Terminal Connection

The G-V terminal is a voltage-free dry contact signal for connecting with generator's NO relay to start up the generator when necessary.

When generator operation is not needed, Pin7 and Pin8 is in open circuit.

When generator operation is needed, Pin7 and Pin8 is in short circuit.

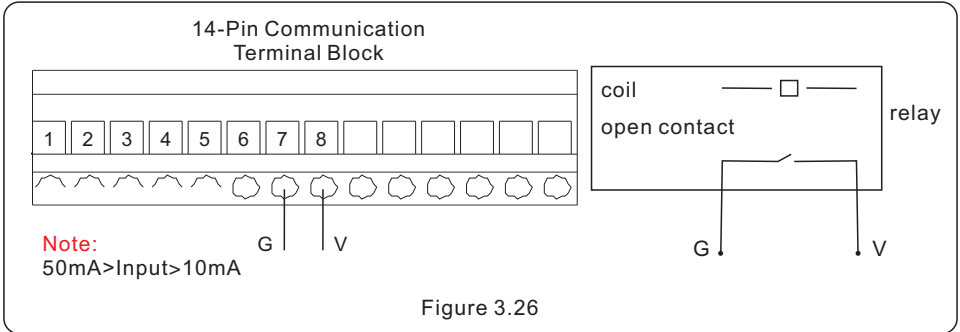

3.10.8.3 ATS380V Terminal Connection

The ATS380V terminal will output 220V AC voltage when inverter is connected to the grid and when inverter is connected to the generator, it will output 0V.

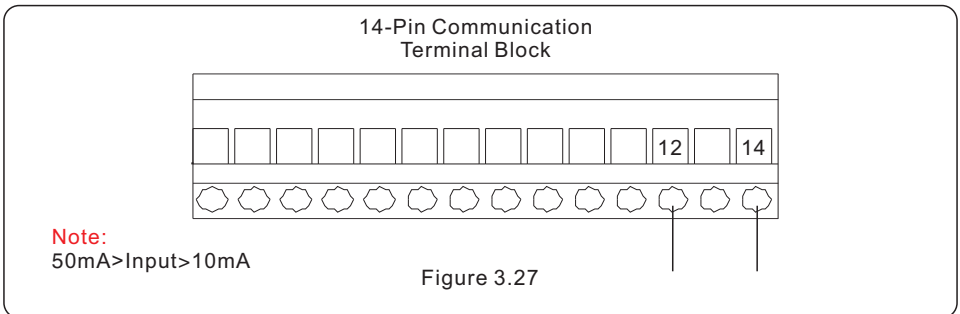

3.11 Diesel Generator Wiring

1. The backup PE must be directly connected to the PE copper bar of the power distribution box, rather than the inverter shell.
2. The generator itself needs to be grounded, connected to the electric box, and connected to the inverter generator port.
3. When the generator is working, disconnect the Grid breaker or leakage current protector on the side of the power box immediately.

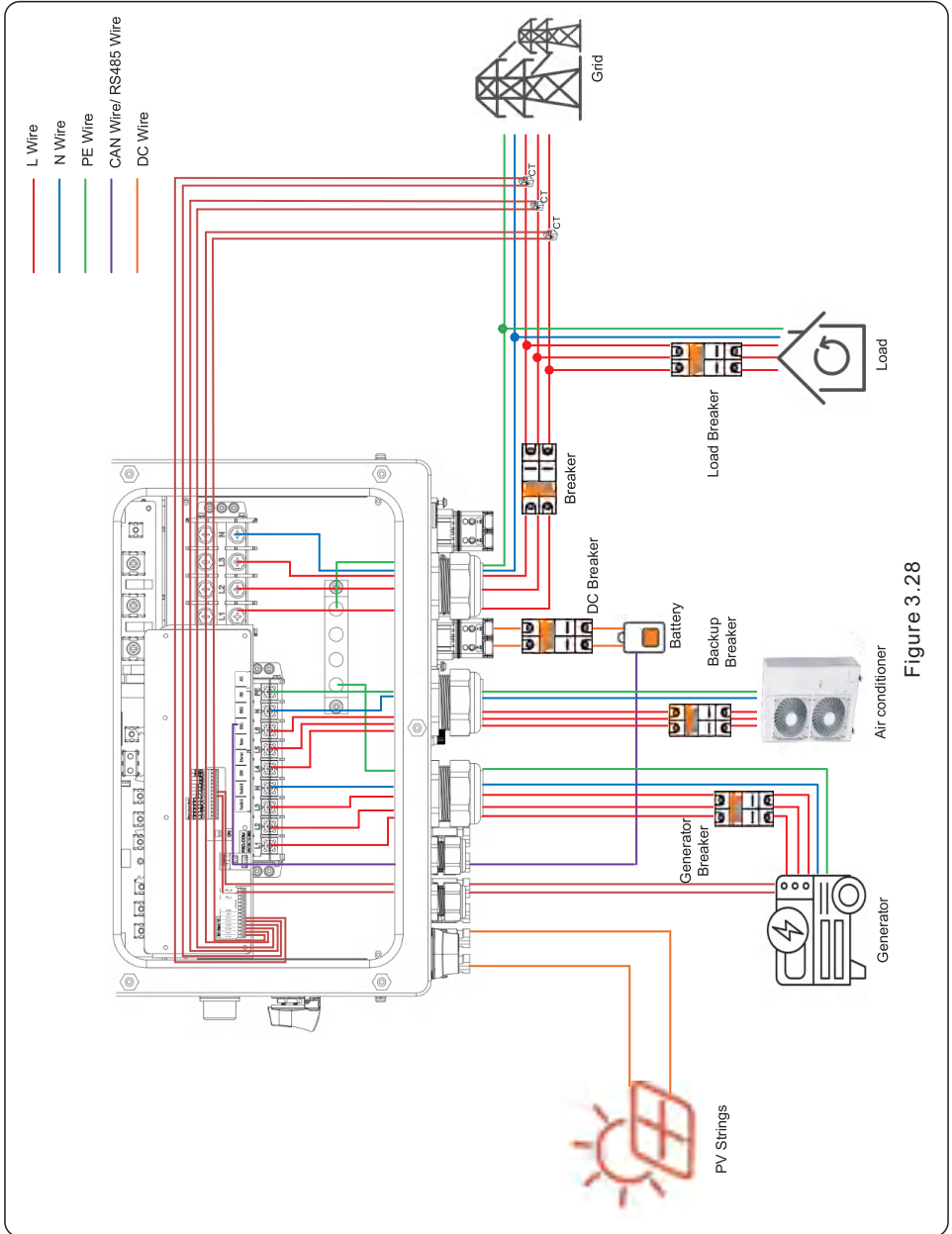

Figure 3.28

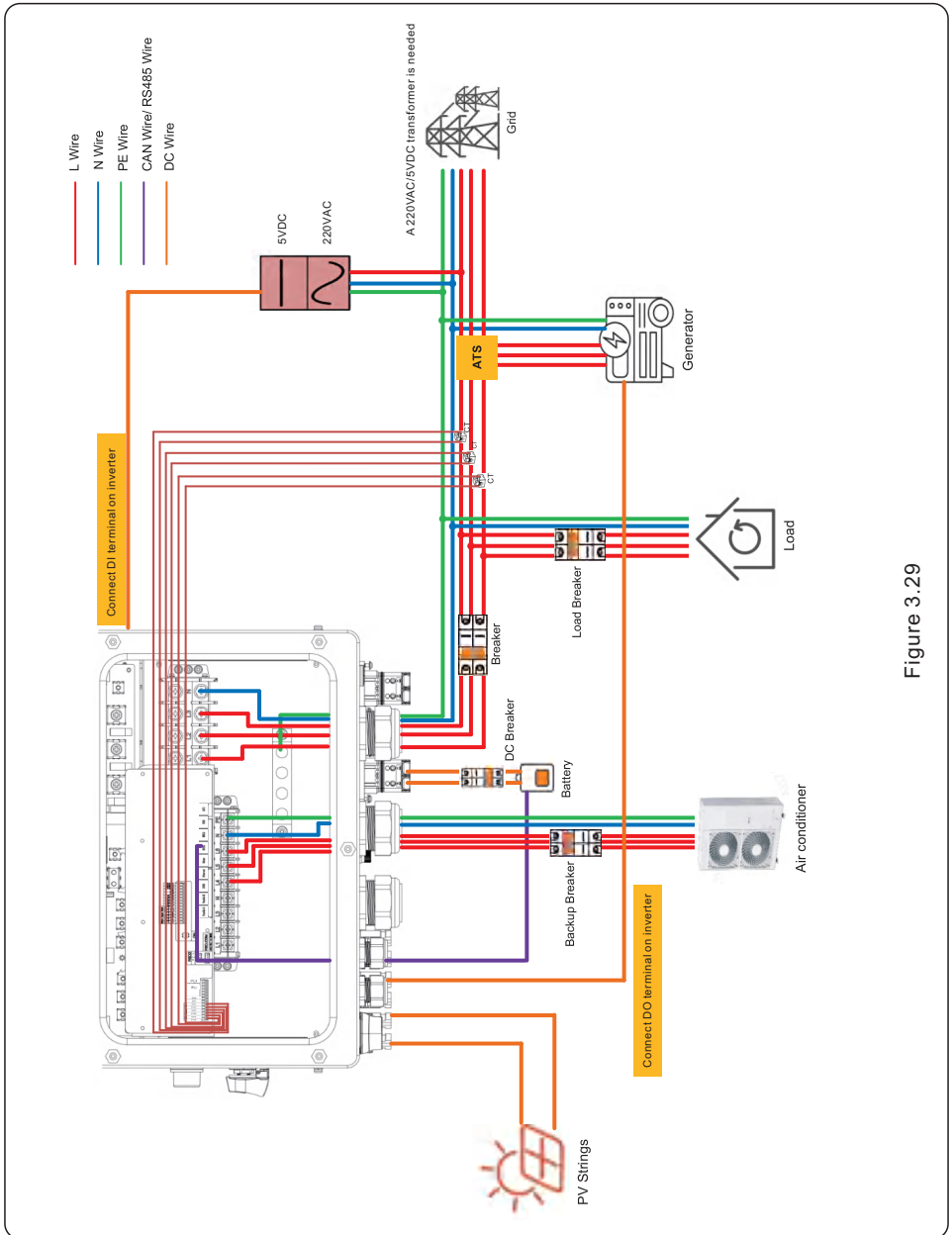

Figure 3.29

3.12 Parallel System Wiring

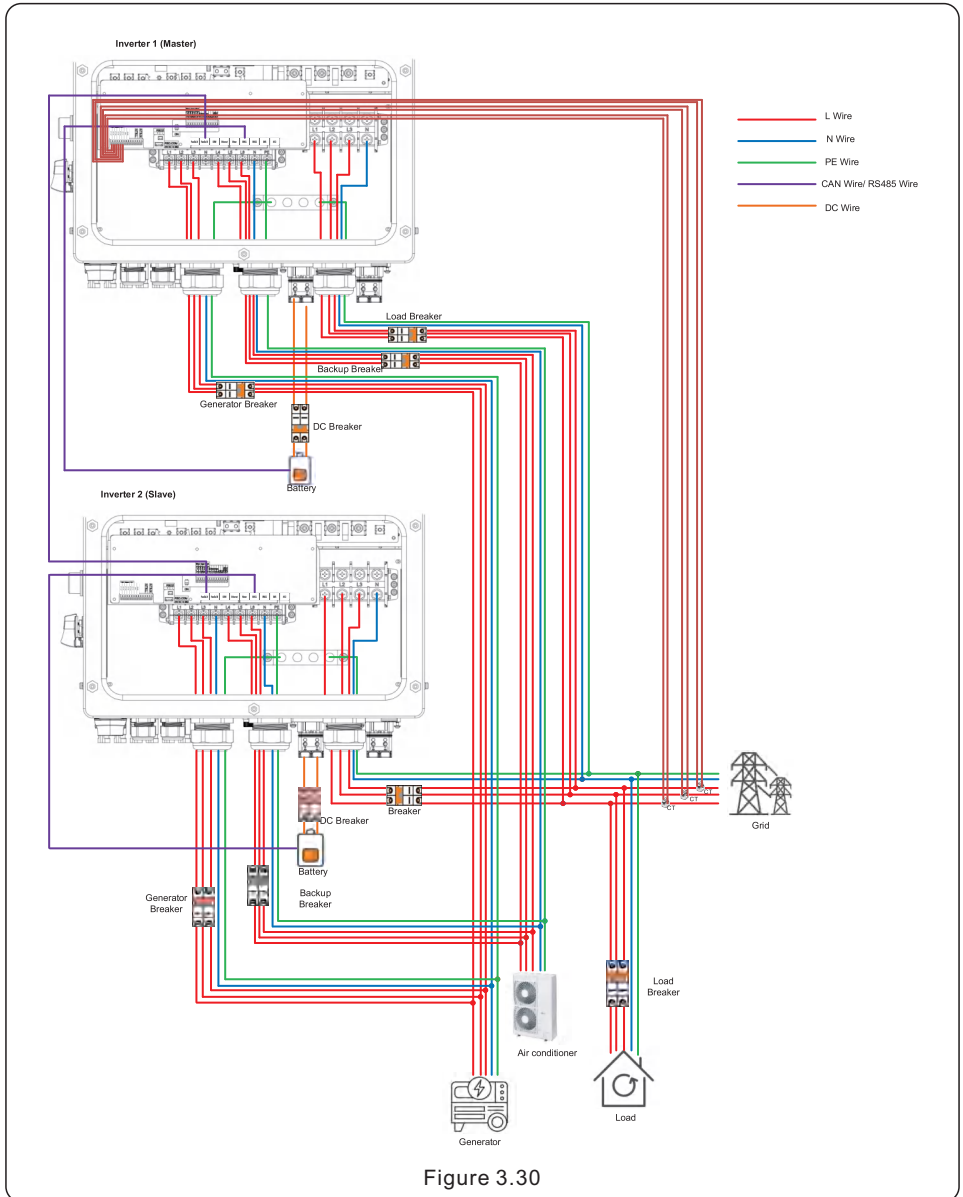

Figure 3.30

3.13 Lithium battery wiring

Inverter supports the 3 wirings methods to connect to lithium battery.

If you have only one battery, you **MUST** connect it to DC 1 port on inverter, and communication cable **MUST** be connected to BMS 1 port on the inside terminal block.



NOTE:

The condition for battery fully charging:

For this series of product, the compatible battery voltage should from 150-800V, but if you want the battery fully charging, you should know the condition(as the below table) for that. When the battery voltage between 400V-500V, the charging current can reach to the maximum value: 70A, and when battery voltage between 500-800 , the single channel charging capacity can reach to the 35KW. For an example. for 50K model, two batteries charging power can reach to 55kw (1.1 times of rated output power) in total.

S6 –EH3P(29.9-50)K-H-AU

NO.	Battery voltage(V)	Battery Current(A)	Battery Power(KW)
1	150	30	4.5
2	200	38	7.6
3	300	54	16.2
4	400	70	28
5	500	70	35
6	550	64	35
7	600	58	35
8	700	50	35
9	800	44	35

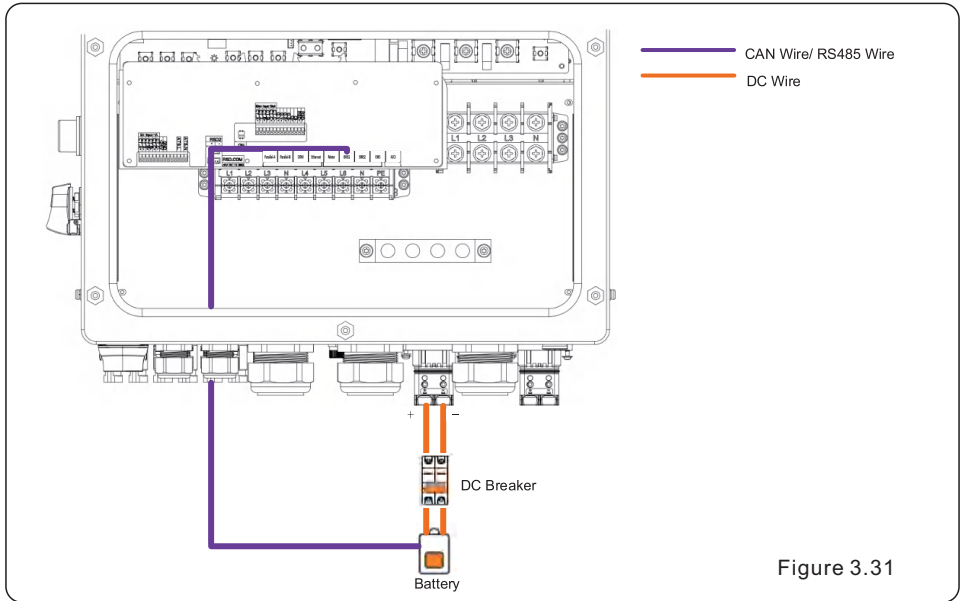

Figure 3.31

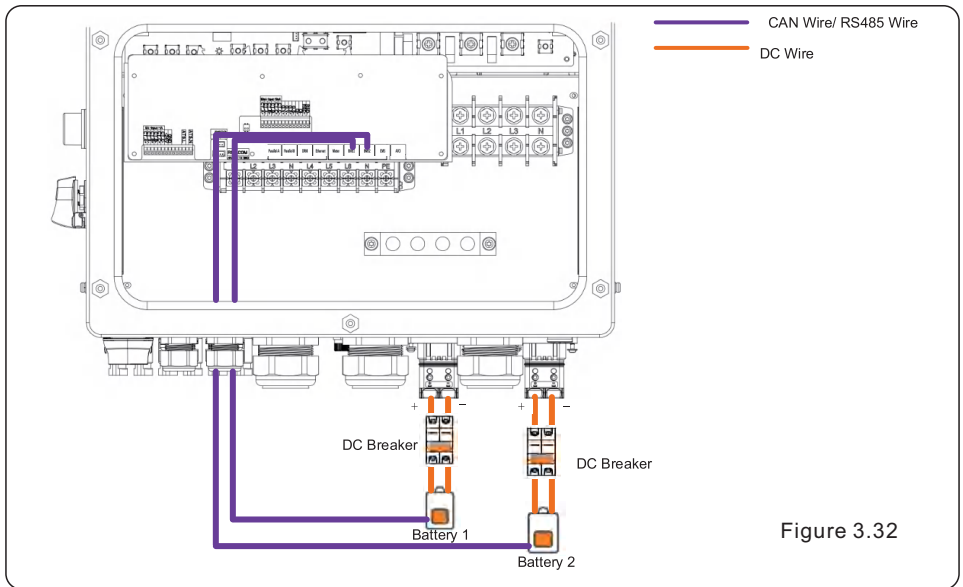
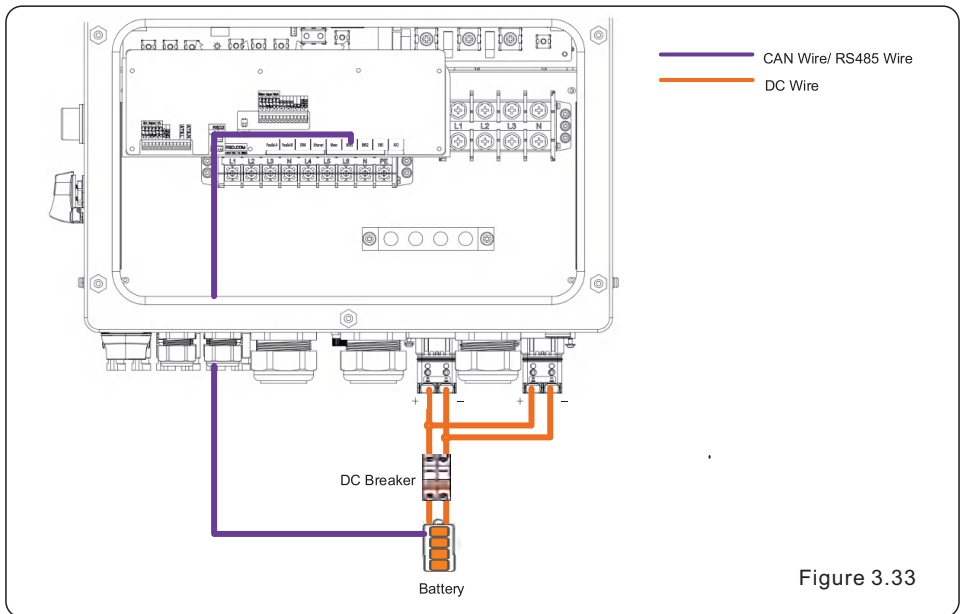

Figure 3.32



NOTE:

For this battery wiring mode, the communication wire must be connected to the BMS 1 port of inverter.



NOTE:

The suggested specification of external AC breakers are as following.

- AC grid port: four-pole, 160A, $I_{cc} \geq 20KA$, I_{cp} , $m_r \geq 800A(5I_n)$
- Backup port: four-pole, 80A, $I_{cc} \geq 20KA$, I_{cp} , $m_r \geq 600A$
- Smart port: four-pole, 80A, $I_{cc} \geq 20KA$, I_{cp} , $m_r \geq 600A$

The temperature limit of wiring terminals for external connections should be lower than 85°C.

3.14 Smart Meter measurement connection method for system

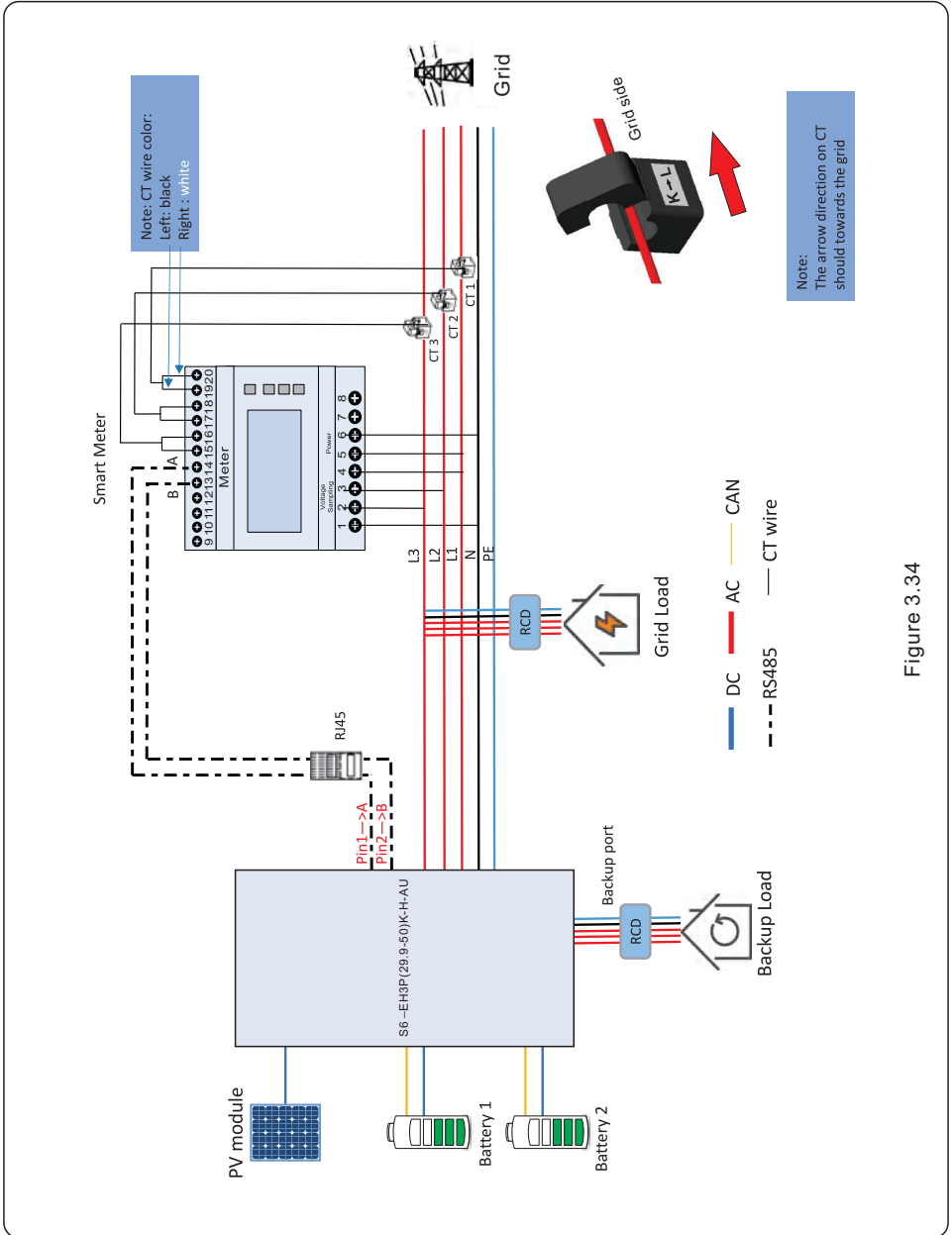

Figure 3.34

3.15 Inverter Remote Monitoring Connection

The inverter can be remotely monitored via WiFi, LAN or 4G.

The USB type COM port at the bottom of the inverter can connect to different kinds of Solis data loggers to realize the remote monitoring on Soliscloud platform.

To install Solis data loggers, please refer to corresponding user manuals of Solis data loggers.

The Solis data loggers are optional and can be purchased separately.

Dust cover is provided the inverter package in case the port is not used.



WARNING:

The USB type COM port is only allowed to connect Solis data loggers. It is forbidden to be used for other purposes.

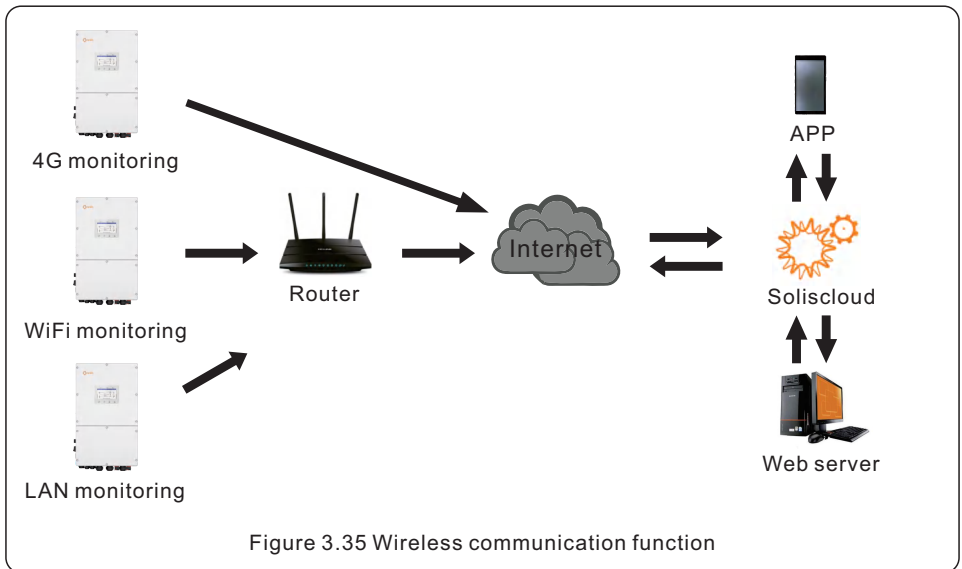
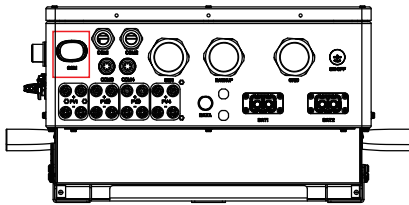
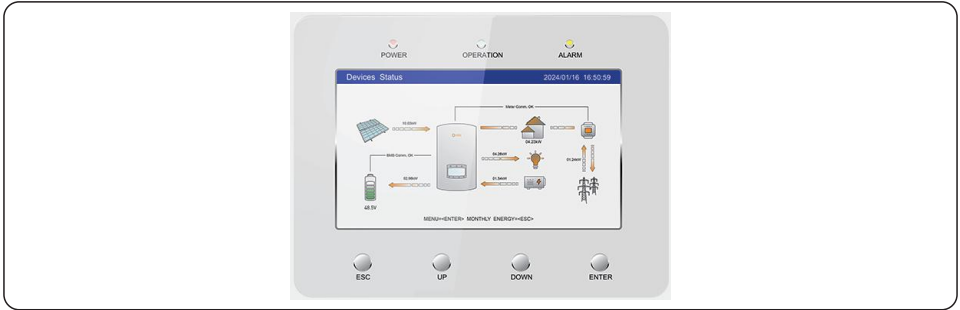

Figure 3.35 Wireless communication function

4.1 HMI Screen

There are 3 indicators and 4 operation button on the Solis S6 Series Inverter.



Description of indicators:

Indicators	Status	Description
POWER	Red light solid on	Normally powering
	OFF	Not working
OPERATION	Green light solid on	Normally powering
	OFF	No operation
ALARM	Yellow light solid on	Alarm
	OFF	Normal

Description of buttons:

Button	Description
ESC	“Escape”, allows the user to exit, or cancel the operation.
UP	Upwards key, allows the user to increase the value or move forward to the next option.
DOWN	Downwards key, allows the user to decrease the value or move backward to the previous option.
ENTER	Running or executing command .



NOTE:

The screen will be automatically turn off after being idle for a few minutes to save power, click any operation button(“ESC”/“UP”/“DOWN”/ “ENTER”) to restart the screen, then press“Enter”into the main operation interface.

4.2 Inverter built-in Bluetooth description

Blueooth: BDR、EDR、BLE

frequency band(s) in which the radio equipment operates:2.402-2.480GHZ

Maximum transmitting power: 8dBm

Hereby, Ginlong Technologies Co.,Ltd.declares that the radio equipment type hybrid inverter is in compliance with Directive 2014/53/EU

5.1 Pre-Commissioning

- Make sure that no high voltage conductors are energized.
- Check all conduit and cable connection points ensure they are tight.
- Verify that all system components have adequate space for ventilation.
- Follow each cable to ensure that they are all terminated in the proper places.
- Ensure that all warning signs and labels are affixed on the system equipment.
- Verify that the inverter is secured to the wall and is not loose or wobbly.
- Prepare a multimeter that can do both AC and DC amps.
- Have an Android or Apple mobile phone with Bluetooth capability.
- Install the Soliscloud APP on the mobile phone and register a new account.
- There are three ways to download and install the latest APP.

1.You can visit www.soliscloud.com.

2.You can search"Soliscloud" in Google Play or APP Store.

3.You can scan this QR code to download Soliscloud.



5.2 Power ON

Step 1: With the DC switch off, energize the PV strings and then measure DC voltage of the PV strings to verify that the voltage and polarity are correct. Turn on the battery and check the battery voltage and polarity as well.

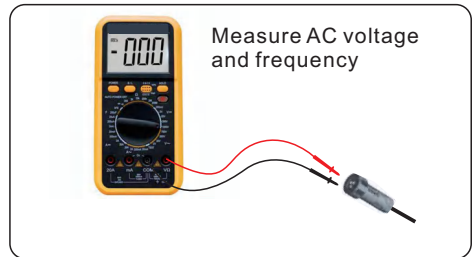
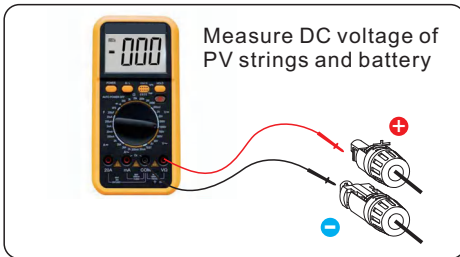

Step 2: Turn on the OCPD for the system and then measure the AC voltages line to line and line to neutral. The backup side of the system will be off until commissioning is complete. Turn the OCPD back off for now.

Step 3: Turn the DC switch on and then the OCPD(AC breaker) for the system.

This inverter can be powered on by PV only, battery only and Grid only.

When the inverter is powered on,the five indicators will be lighted at once.

5.3 Power OFF

Step 1: Turn off the AC breaker or AC disconnect switch to disable AC power to the inverter.

Step 2: Turn off the DC switch of the inverter.

Step 3: Turn off the battery breaker.

Step 4: Use a multimeter to verify that the battery and AC voltages are 0V.

5.4 HMI Screen Setting

5.4.1 HMI Quick Setting

If this is the first time the inverter has been commissioned, you will need to first go through the Quick Settings. Once this has been done, these settings can be changed later.

Inverter Time -> Meter Setting -> Grid Code -> Storage mode -> Battery Model

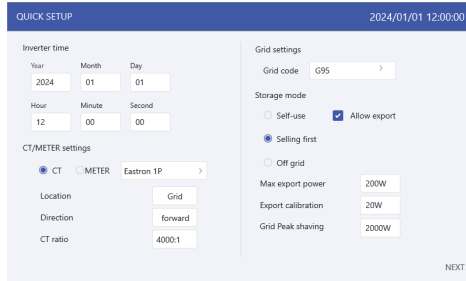

1. Inverter time:

Set inverter time and date, default follow the phone.

2. CT/Meter setting:

Select the CT or Meter, Solis provide Eastron 3 phase meter, it is self-identifiable.

Set installation location: Grid side / Load side / Grid+PV inverter;

CT direction: When CT installed correctly, select "Forward"; when CT installed direction wrong, the sampling current of CT will be reversed when calculating the power, select "Reversal" to correct it.

Set CT ratio: default 60 (Solis provide ESCT-T50-300A/5A CT), if the user install their own CT, then need to set the CT ratio manually. If the system connected to Meter, then CT ratio need to be set on Meter.

3. Grid code:

Select grid code that meet the local regulations.

4. Storage mode:

ALL modes first priority is to use the available PV power to support loads. The different modes determine what the second priority, or use of the excess PV power, will be.

Self-use / Selling first / Off-grid are exclusive, the user could select only one mode.

Mode	Description
Self-use	<p>PV power flow priority sequence: loads > battery > grid. In this mode, the system stores excess PV power into the battery after the loads are supplied.</p> <p>If "Allow export" turned on, when the battery is charged full, or there is no battery, the excess PV power will be exported(sold)back to the grid.</p> <p>If the system is set to not export any power, then the inverter will curtail the PV power (derate the inverter output power).</p>
Selling first	<p>PV power flow priority sequence: loads > grid > battery. In this mode, the system exports any excess PV power after the loads are supplied. If the export power quota has been met, then the remaining PV power will be stored in the battery.</p> <p>Notice: This mode should not be used if export power set to zero.</p>
Off grid	<p>PV power flow priority sequence: loads > battery. This mode only used when the system are not electrically connected to the grid at all. This mode is like Self-Use Mode, but the PV power will be curtailed if the PV power output is > battery power + load power</p>

Table 1 Description of modes

Under each mode, user could set other functions based on their requirements.

Settings	Description
Max export power	<p>Default: 1.1 times of rated power. Notice: if feed-in is not allowed, set Max export power to 0.</p>
Export calibration	<p>Range : -500w-500w, default 20w, settable. To compensate the deviation of CT/Meter in practical application.</p>
Grid peak shaving	<p>Default enable, default 2 times of rated power. Limit the power drawn from the grid to prevent from exceeding regulatory requirements or the power line capacity. It works only when the "battery reserve" turned on.</p>

Table 2 Description of mode settings

5. Battery setting:

Select Battery connection method: 1 Batt 1 DC / 1 Batt 2 DC / 2 Batt 1 DC; the connection method please refer to 3.13 Lithium battery wiring.

Select battery brand (if the connected battery is not on the list, please select “General_LiBat_HV”).

Set Max charging/discharging current.

If there are two batteries and share the same settings, please tick the box of “Batt2 Settings follow Batt 1”.



5.4.2 HMI screen operation system overview

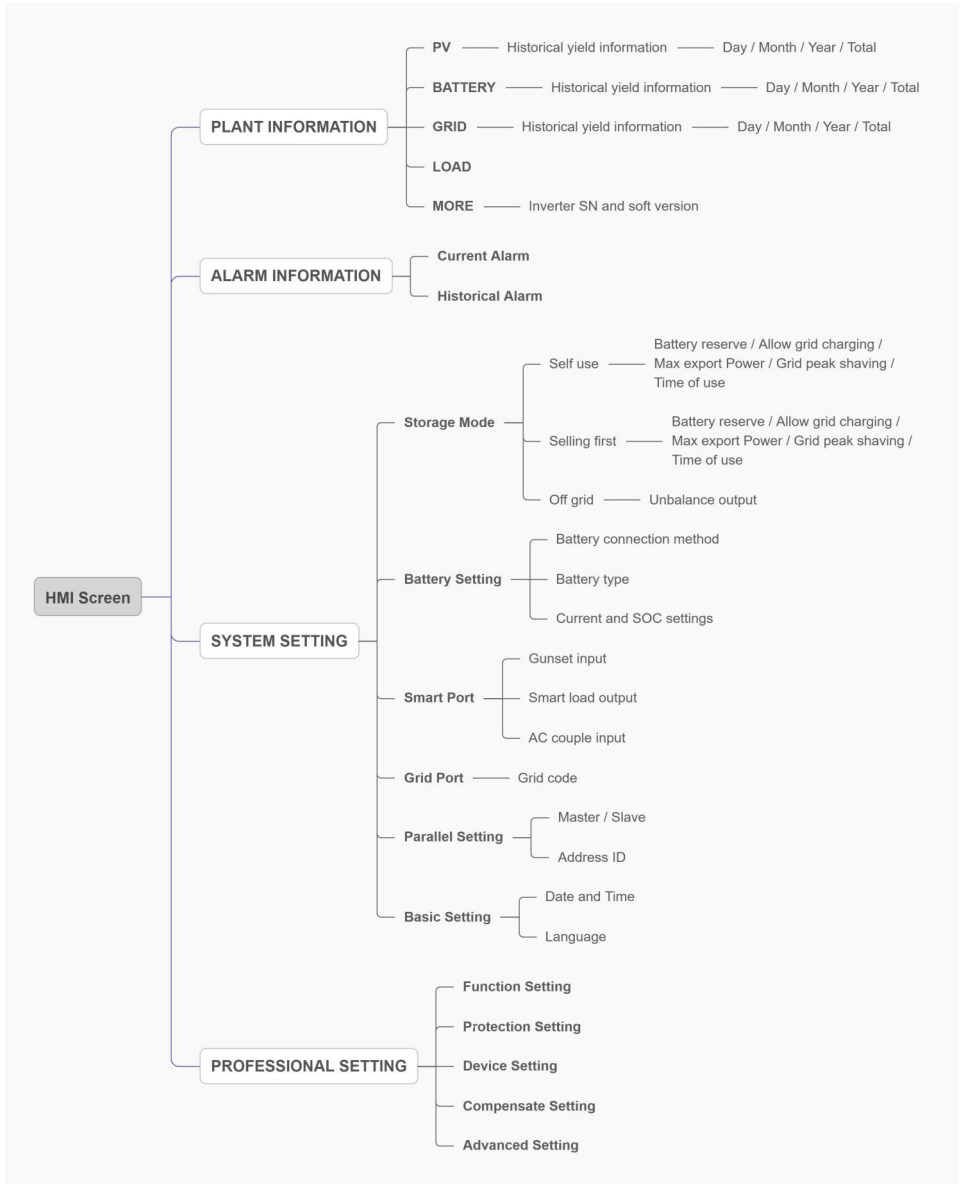

5.4.3 Detailed HMI Setting

Step 1: Enter Home page

After quick setting, press “ENTER”, the screen displays the home page.

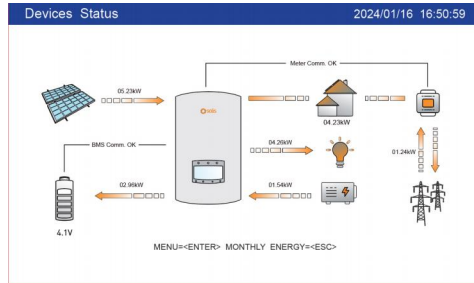

The screen will be automatically turn off after being idle for a few minutes to save power, click any operation button (“ESC”/“UP”/“DOWN”/“ENTER”) to restart the screen, then press “Enter” into the main operation interface.

Step 2: Enter “SYSTEM SETTING” interface

Press “Down” button, then press “ENTER” into the “SYSTEM SETTING” interface.

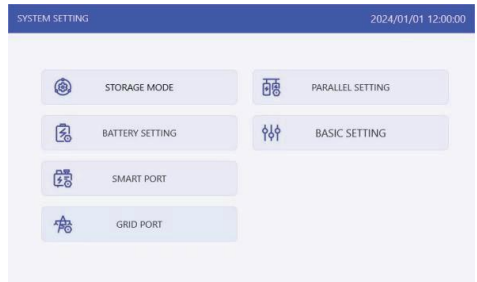

Step 3: Set “Storage Mode”

Use “UP” or “DOWN” key to select the desired mode, then press “ENTER”.

The Mode description please refer to 5.4.1.

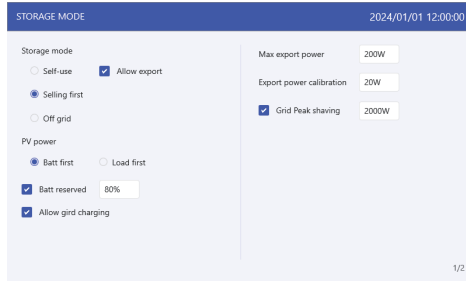

Settings	Description
Battery reserve	Range: 5~95%, default: 80%, settable. When battery SOC < set battery reserve SOC, battery will stop discharging.
Allow grid charging	Allow grid charging the battery when it enables. Notice: if “Allow Grid Charging” is turned on, the inverter will use grid power to charge the battery only under two circumstances: The battery drains to the Force Charge SOC. When PV power output can’t meet the set current value during the charge periods.
Max export power	Default: 1.1 times of rated power. Notice: if feed-in is not allowed, set Max export power to 0.
Export calibration	Range : -500w-500w, default 20w, settable. To compensate the deviation of CT/Meter in practical application.
Grid peak shaving	Default enable, default 2 times of rated power. Limit the power drawn from the grid to prevent from exceeding regulatory requirements or the power line capacity. It works only when the “battery reserve” turned on.

Table 3 Description of storage mode settings

Step 4: Set “Time of use” under each mode (Skip this step if no need)

Time of Use is for manual control of the battery charging/discharging. It is for customizing when the battery is allowed to charge and discharge power and at what rate, established by a current(amperage)setting.

1. Charge period: battery charges with set current value until the charging cut-off voltage (settable), checking the box to control whether enable this charging period.
2. Discharge period: battery discharges with set current value until the discharging cut-off voltage (settable), checking the box to control whether enable this discharging period.

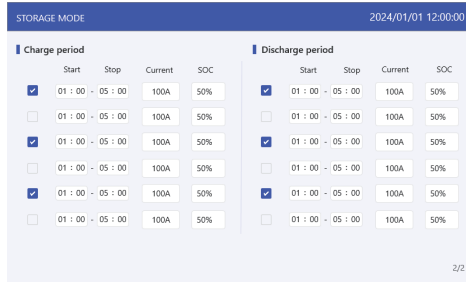

Step 5: Set “Battery Setting”

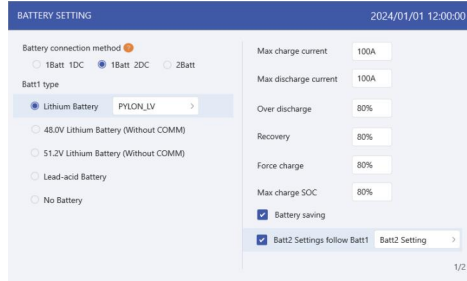

Settings	Description
Max charge current	Max charge current, settable.
Max discharge current	Max discharge current, settable.
Over discharge	Range: 5~40%, default 20%, when battery SOC < over discharge, it will stop discharging.
Recovery	Range : set Over discharge value +1% ~ set Over discharge value +20%; Battery won't stop charging until it reaches Recovery SOC value, reserve the return difference value to avoid the battery repeatedly cross jump between charging and discharging.
Force charge	Range: 4%~ set Over discharge value when battery SOC > force charge SOC, the grid will charge the battery.
Max charge SOC	Charge cut-off SOC, battery stops charging when reach the Max. Charge SOC.

Table 4 Description of battery mode settings



NOTICE:

Force charge SOC < Over discharge SOC < Recovery SOC, otherwise the setting might be error.

Step 6: Set “Grid Port”

(Skip this step if grid code is already set in quick setting)

Select grid code that meet the local regulations.

Three level of Over-voltage / under-voltage / Over-frequency / under-frequency are default based on grid code, there is no need to set the parameters in manual.

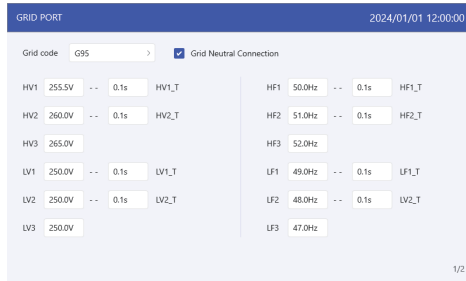

Step 7: Set “Smart Port”

(Skip this step if the system is not connected to generators)

When it is connected to Generator, select “Gunset input”;

When it is connected to smart load like heat pump, select “Smart load output”

When it is connected to Grid-tied inverter, select “AC coupled”

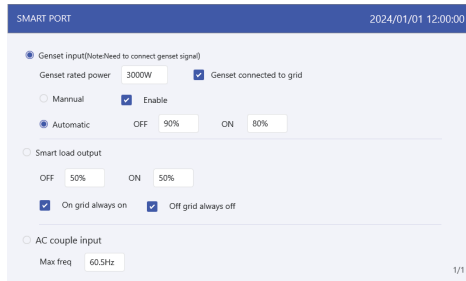

Genset

The user need to input the “Genset rated power” by manual.

OFF: Generator stops charging SOC, settable, range:35~100%;

ON: Generator start charging SOC; settable, range:1~95%;

AC coupled:

Max Freq: Grid-tied inverter stops charging frequency, settable,

If grid Level 1 over-frequency threshold <55Hz,

Range: Level 1 over-frequency threshold~ Level 1 over-frequency threshold+ 0.1Hz~54Hz;

If grid Level 1 over-frequency threshold <65Hz,

Range: Level 1 over-frequency threshold~ Level 1 over-frequency threshold+ 0.1Hz~65Hz;

Step 8: Set parallel system

Set Master and Slave machine,

Set Master ID as: 1

Slave machine ID as: 2

.Slave machine ID as: 3

..... and so on.



5.5 APP Setting

5.5.1 Log in the APP via Bluetooth

Step 1: Connect with Bluetooth.

Turn on Bluetooth switch on your mobile phone and then open the Soliscloud APP.

Click "More Tools"->"Local Operation"->"Connect with Bluetooth"

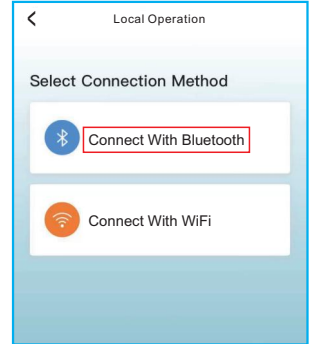
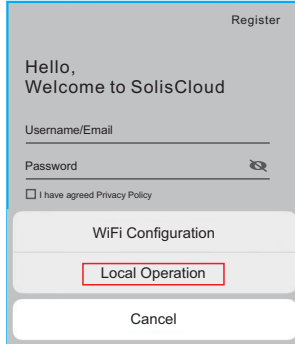
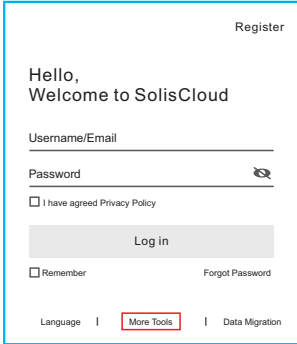

Step 2: Select the Bluetooth signal from the inverter. (Bluetooth Name: Inverter SN)



Step 3: Login account.

If you are the installer, please select the account type as Installer. If you are the plant owner, please select the account type as owner. Then set your own initial password for control verification. (The first log-in must be finished by installer in order to do the initial set up)

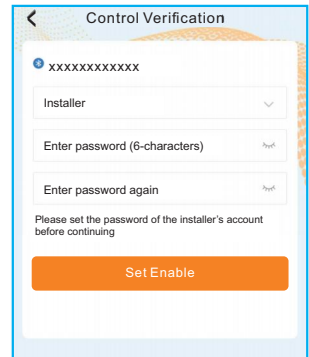
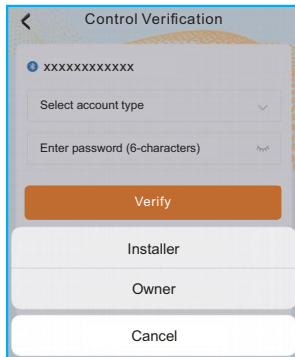
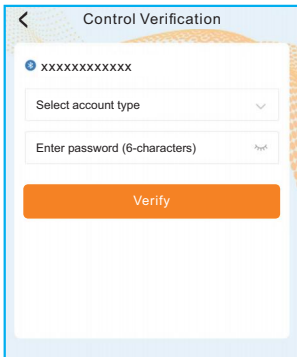

5.5.2 APP Quick Setting

If this is the first time the inverter has been commissioned, you will need to first go through the Quick Settings. Once this has been done, these settings can be changed later.

Inverter Time -> Meter Setting -> Grid Code -> Storage mode -> Battery Model

(1) Inverter time:

Set inverter time and date, tap the slider next to "Follow Phone Time", then tap "Next step" at the bottom right corner.

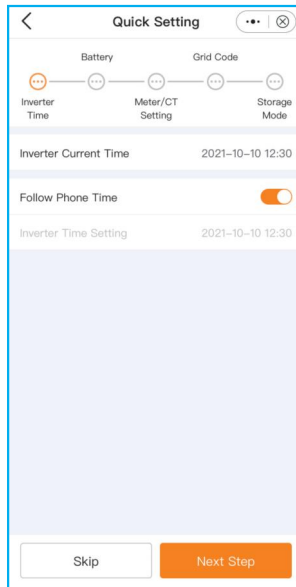

(2) Battery:

- Select number of battery banks : 1-2 ;
- Select battery model: if the connected battery brand is not on the list, please select "General_LiBat_HV"
- Select battery connection method.

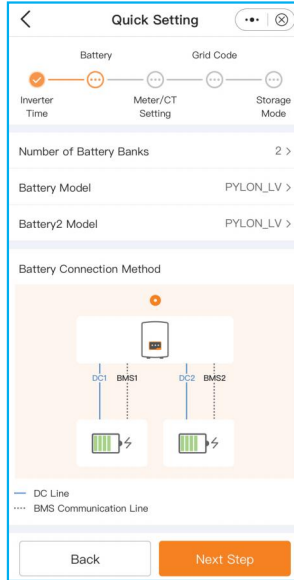
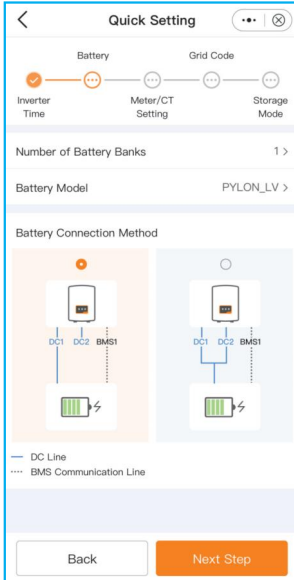

(3)CT/Meter setting:

- Select CT or Meter;
- Set Meter type (Solis provide Eastron 3 phase meter, it is self-identifiable).
- Set Meter installation location: Grid side / Load side / Grid+PV inverter;
- Set CT ratio: default 60 (Solis provide ESCT-T50-300A/5A CT), if the user install their own CT, then need to set the CT ratio manually. If the system connected to Meter, then CT ratio need to be set on Meter.
- CT direction: When CT installed correctly, select “Forward”; when CT installed direction wrong, the sampling current of CT will be reversed when calculating the power, select “Reversal” to correct it.

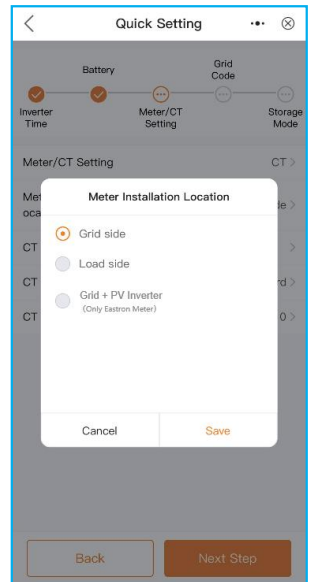
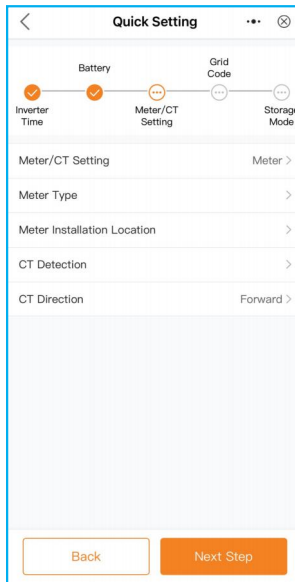

(4)Grid code:

Select grid code that meet the local regulations.

Three level of Over-voltage / under-voltage / Over-frequency / under-frequency are default based on grid code, there is no need to set the parameters in manual.

Parameter	Value	Time	Type
Grid Code	EN50549NL		
HV1	253.0V	1.20s	HV1_T
HV2	253.0V	1.20s	HV2_T
HV3	6553.5V	-0.01s	HV3_T
LV1	184.0V	1.20s	LV1_T
LV2	184.0V	1.20s	LV2_T
LV3	57.5V		
HF1	51.00Hz	1.20s	HF1_T
HF2	51.00Hz	1.20s	HF2_T
LF1	48.00Hz	1.20s	LF1_T
LF2	48.00Hz	1.20s	LF2_T
Startup-VH	253.0V		>
Startup-VL	195.5V		>
Recover-VH	253.0V		>
Recover-VL	195.5V		>

Country/Region
General
User-define
Other
A
Aruba
Australia
Austria
B
Barbados
Belgium
Brazil
C
Chile
China
Cyprus
Czech
D

(5)Storage mode:

ALL modes first priority is to use the available PV power to support loads. The different modes determine what the second priority, or use of the excess PV power, will be.

Self-use / Selling first / Off-grid are exclusive, the user could select only one mode.

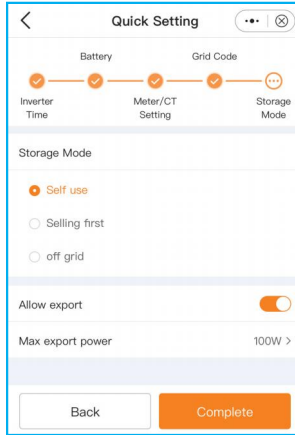

Settings	Description
Self-use	PV power flow priority sequence: loads > battery > grid. In this mode, the system stores excess PV power into the battery after the loads are supplied. If the battery is charged full, or there is no battery, the excess PV power will be exported(sold)back to the grid. If the system is set to not export any power, then the inverter will curtail the PV power (derate the inverter output power).
Selling first	PV power flow priority sequence: loads > grid > battery. In this mode, the system exports any excess PV power after the loads are supplied. If the export power quota has been met, then the remaining PV power will be stored in the battery. Notice: This mode should not be used if export power set to zero.
Off grid	PV power flow priority sequence: loads > battery. This mode only used when the system are not electrically connected to the grid at all. This mode is like Self-Use Mode, but the PV power will be curtailed if the PV power output is > battery power + load power.

Table 5 Description of Storage modes

Once quick setting finished, tap "Complete", the APP enter the homepage.

5.5.3 APP interface structure

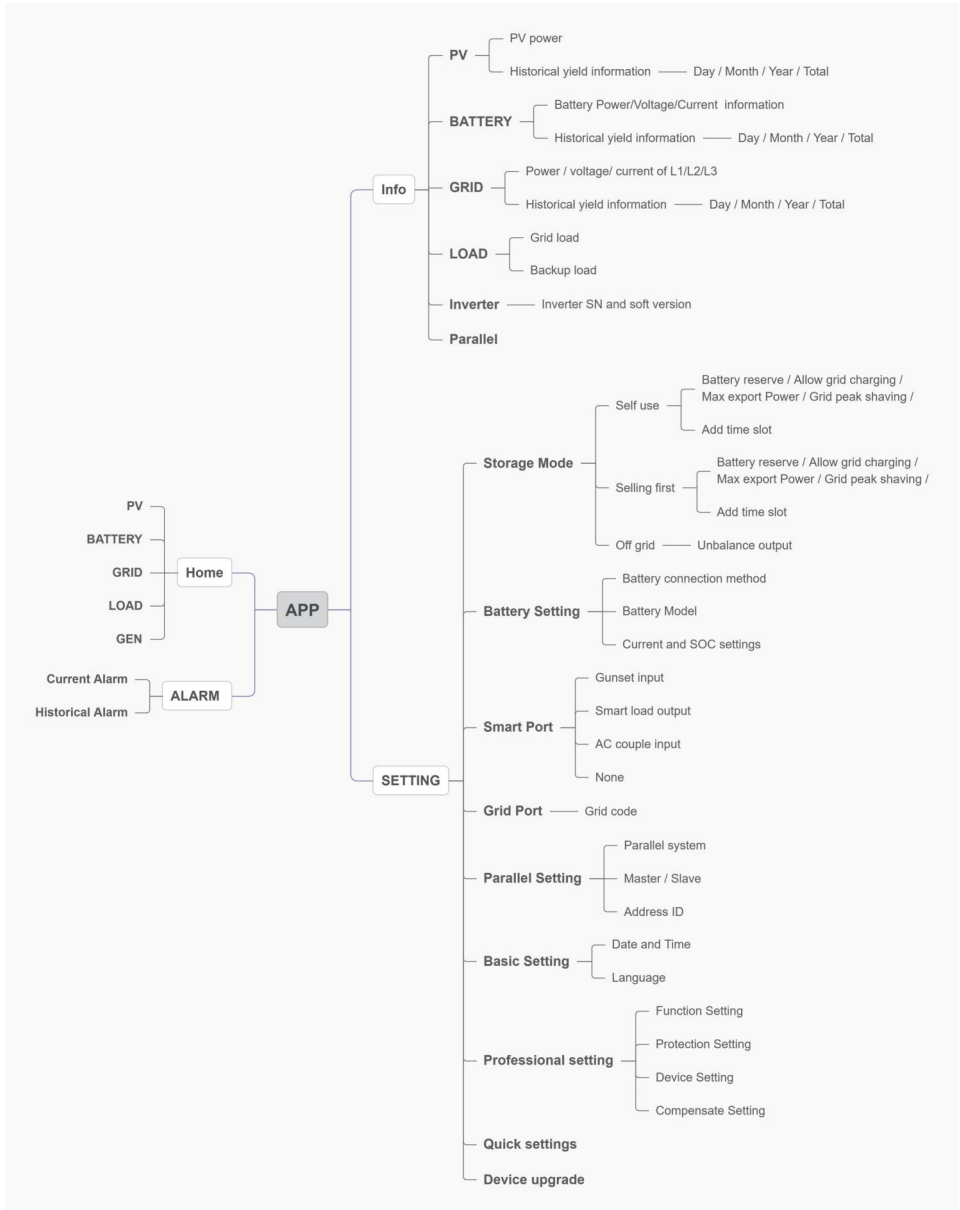

5.5.4 Home

This screen display energy production and consumption, as well as its flow. It shows the following data:

- Today yield of PV
- Today Imported/Exported of Grid
- Today Charged/Discharged of Battery
- Today Consumption of Grid-side load
- Today Consumption of Back-up load
- Today GEN yield.

At the bottom of page are four sub menus: Home, Info, Alarm and Settings.



5.5.5 Setting

Under this page, the user could find quick setting and other detailed settings as follows:

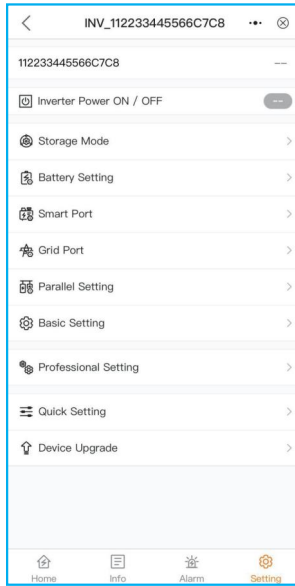

1. Storage mode

a. Select storage mode:

- Self-use / Selling first / Off-grid, these three modes are exclusive, the user could select only one mode. The modes definition could refer to 5.5.2“Quick setting”
- The Mode description please refer to 5.4.1.

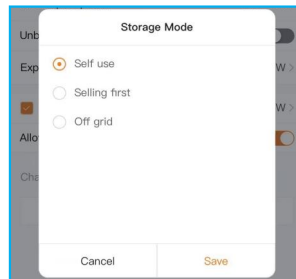
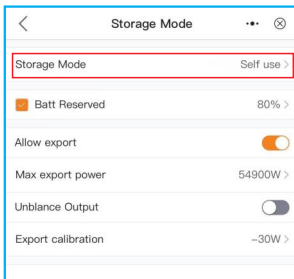

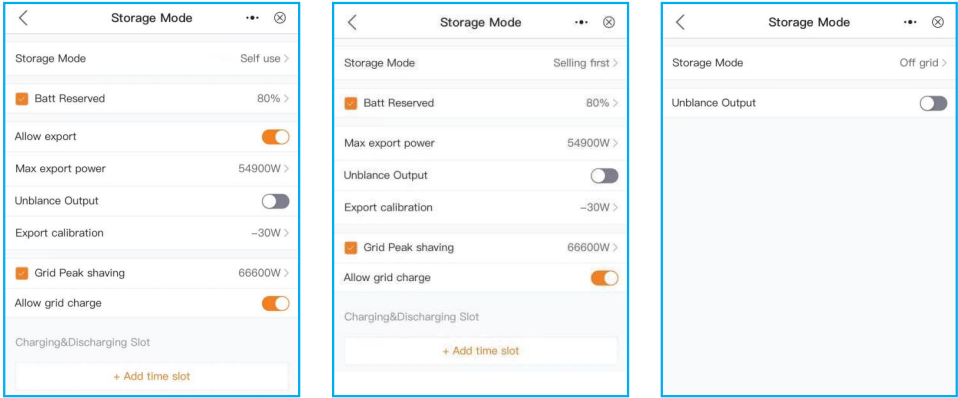

Please notice:

“Allow export” can only be set in “Self use” mode;

“Add time slot” can only be set in grid-connected mode (Self use” mode and “ Selling first” mode).

b. Set mode operations:

Settings	Description
Battery reserved	Range: 5~95%, default:80%, settable. When battery SOC < set battery reserve SOC, battery will stop discharging.
Allow export	When it enables, the system is allowed to export power to grid.
Max export power	Default: 1.1 times of rated power. Notice: If feed-in is not allowed, set Max export power to 0.
Export calibration	Range : -500w-500w, default 20w, settable. To compensate the deviation of CT/Meter in practical application.
Allow grid charging	Allow grid charging the battery when it enables. Notice: if “Allow Grid Charging” is turned on, the inverter will use grid power to charge the battery only under two circumstances: <ul style="list-style-type: none"> •The battery drains to the Force Charge SOC. •When PV power output can't meet the set current value during the charge periods.

Table 6 Set mode operations

c. Add time slot:

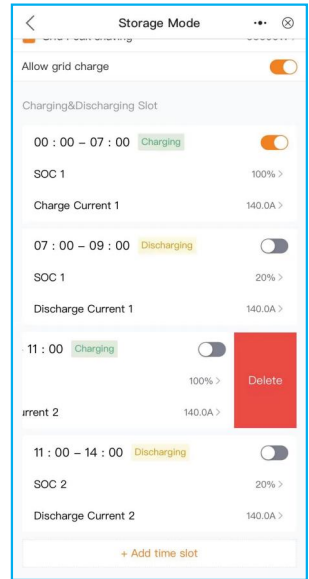
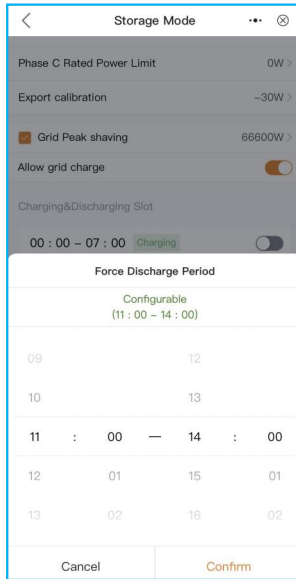
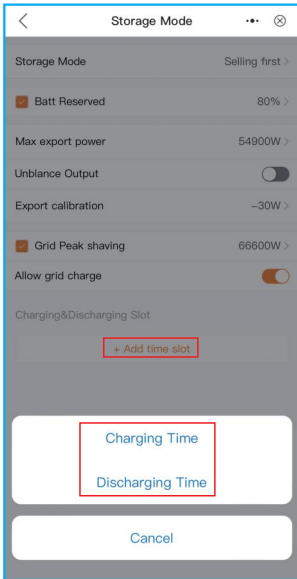

Charge SOC: battery charging stops when reach the set SOC;
Discharge SOC: battery discharging stops when reach the set SOC.



NOTICE:

- Slide the switch to on, the battery charge/discharge with set charge/ discharge current by following the set period
- Slide to the left of screen, the user could delete the current period setting.

2. Battery setting

- Set “Number of Battery Banks” and “Battery Model”
- Set “Battery Connection Method” : 1 Batt 1 DC / 1 Batt 2 DC / 2 Batt 1 DC;
- Set battery parameters

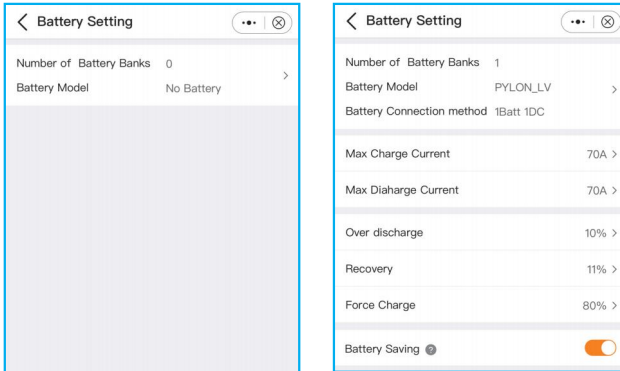

Settings	Description
Max charge current	Max charge current, settable.
Max discharge current	Max discharge current, settable.
Over discharge	Range : 5~40%, default 20%, when battery SOC < over discharge, it will stop discharging.
Recovery	Range : set Over discharge value +1% ~ set Over discharge value +20%; Battery won't stop charging until it reaches Recovery SOC value, reserve the return difference value to avoid the battery repeatedly cross jump between charging and discharging.
Force charge	Range : 4%~ set Over discharge value, when battery SOC < force charge SOC, the grid will charge the battery.

Table 7 Battery setting



NOTICE:

Force charge SOC < Over discharge SOC < Recovery SOC, otherwise the setting might be error.

d. If two battery banks share the same setting, then turn the “Apply Batt1 parameter values” on. It will match the settings of battery bank 1 automatically.



3. Smart port

Select smart port type

- When it is connected to Generator, select “Gunset input”;
- When it is connected to smart load like heat pump, select “Smart load output”
- When it is connected to Grid-tied inverter, select “AC coupled”

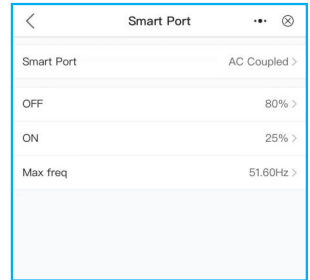
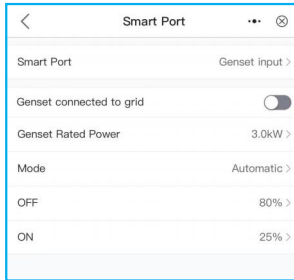
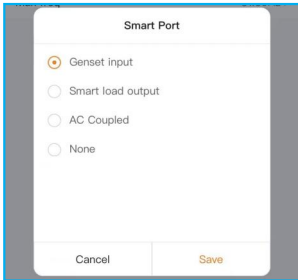

Genset Rated Power: manual input.

OFF: Generator stops charging SOC, settable, range:35~100%;

ON: Generator start charging SOC; settable, range:1~95%;

AC coupled:

OFF: Grid-tied inverter stops charging SOC, settable, range:35~100%;

ON: Grid-tied inverter start charging SOC; settable, range:1~95%;

4. Grid port

Please refer to "5.5.2 APP Quick setting"

5. Parallel setting

When there are ≥ 2 inverters in parallel, turn the slider on

Set Master and Slave machine,

Set Master ID as: 1

Slave machine ID as: 2

.Slave machine ID as: 3

..... and so on.

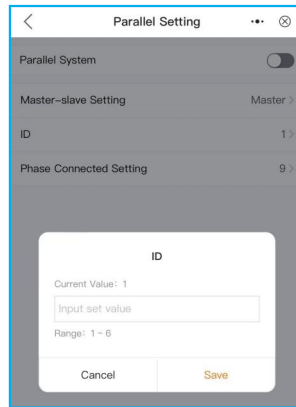
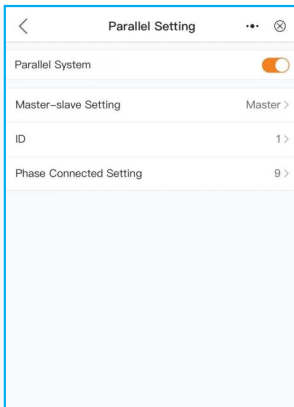

6. Basic setting

Set inverter time and date, tap the slider next to "Follow Phone Time", then tap "Save".

7. CT/Meter setting

There are two ways for CT/Meter setting, detailed setting please refer to “5.5.2 APP Quick setting”.

Method 1: Quick setting

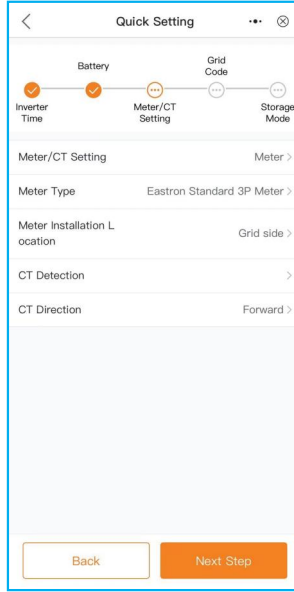
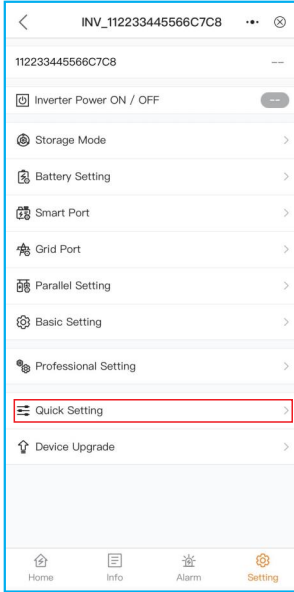

Method 2: Setting --- Professional Setting -- Device Setting --Meter/CT Setting

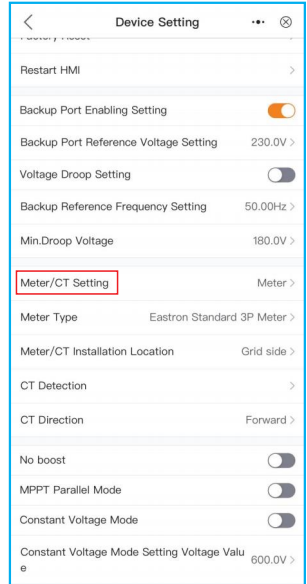
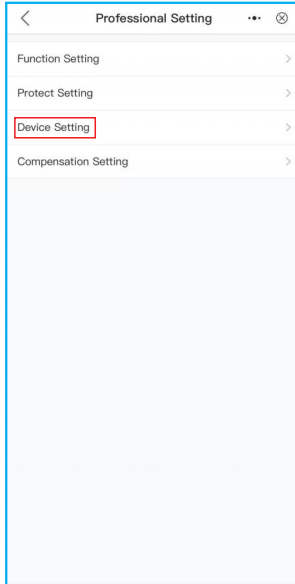
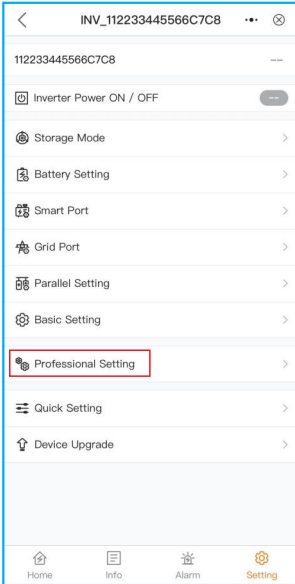

5.5.6 Alarm

The alarm page can display the current alarm and the historical alarms.

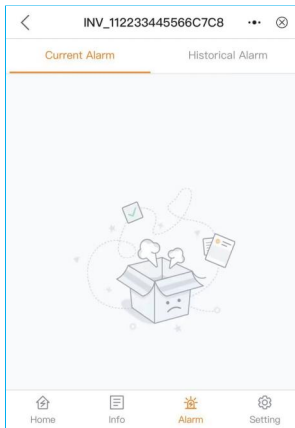

5.5.7 Information

The use could Query information of PV / Battery / GRID / LOAD / INVERTER.

PV : it display each PV module Power/Voltage/Current, as well as historical yield information calculated by monthly / yearly / total, displayed with graphics;

BATT: it display battery Power/Voltage/Current/SOC/SOH/Max.charging current / Max.discharging current, as well as historical battery charging and discharging information calculated by monthly / yearly / total, displayed with graphics;

GRID: it display Active power / voltage/ current of L1/L2/L3, as well as historical exported/imported information calculated by monthly / yearly / total, displayed with graphics;

LOAD: it displays power/voltage of grid load, power/voltage/current of backup load;

INV: it displays inverter SN/model number, and software version.

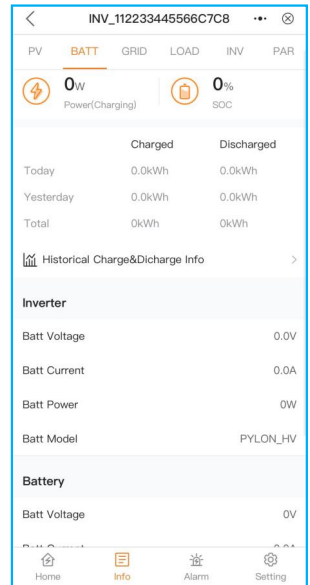
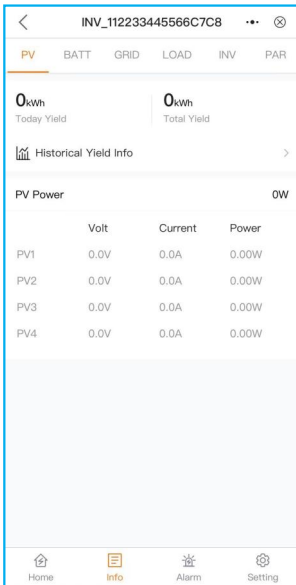

INV_112233445566C7C8

PV BATT **GRID** LOAD INV PAR

0kWh
Today Exported

0kWh
Total Exported

0kWh
Today Imported

0kWh
Total Imported

Historical Exported&Imported Info

Inverter

	L1	L2	L3
Active Power	0W	0W	0W
Voltage	0V	0V	0V
Current	0A	0A	0A

Total Power 0W

Frequency 0.00Hz

Meter

	L1	L2	L3
Active Power	0W	0W	0W
Voltage	0V	0V	0V

Home Info Alarm Setting

INV_112233445566C7C8

PV BATT GRID **LOAD** INV PAR

0kWh
Today Grid Load

0kWh
Total Grid Load

0kWh
Today Backup Load

0kWh
Total Backup Load

Grid Load

	L1	L2	L3
Power	0W	0W	0W
Voltage	0.0V	0.0V	0.0V

Backup Load

	L1	L2	L3
Power	0W	0W	0W
Voltage	0.0V	0.0V	0.0V
Current	0.0A	0.0A	0.0A

Home Info Alarm Setting

INV_112233445566C7C8

PV BATT GRID LOAD **INV** PAR

Inverter

SN 112233445566C7C8

Model 5305

Rated Power 50kW

DSP Version V0000

ARM Version V0378

HMI Version V010F

AFCI Version V0000

Inverter Time 2024-08-01 16:02:09

Genset

Today Yield 0.0kWh

Total Yield 0kWh

Power 0W

Frequency 0.00Hz

Home Info Alarm Setting

5.5.8 CERT mode setting

Solis AU version inverters have the following working mode settings:

1. NULL
2. P Mode Settings
3. Q Mode Settings
4. Fix PF
5. Fix Reactive
6. P-Factor

APP setting step:

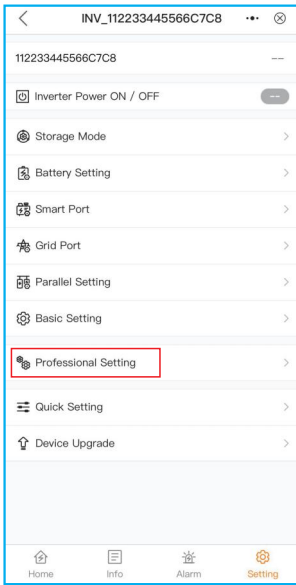

Step1

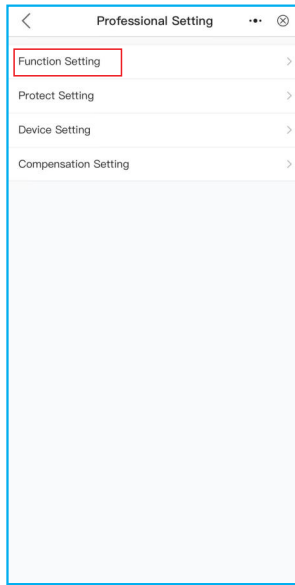

Step2

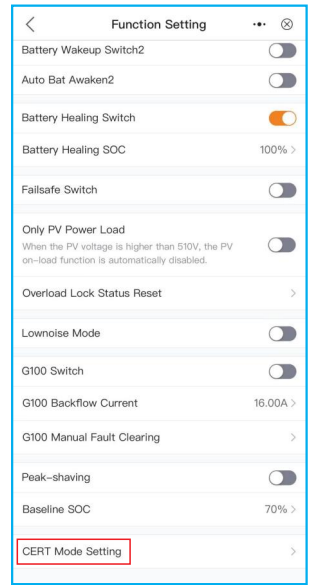

Step3

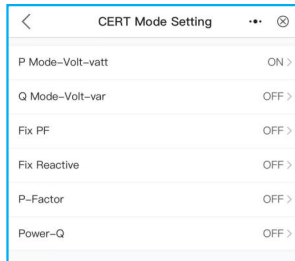

Step4

1. NULL

Description: Inverter will not be under any working mode.

2. P Mode Settings

This P Mode Settings include 1 working mode: Volt-Watt

2.1 Volt-Watt

Description: Inverter will change the active output power based on grid voltage.

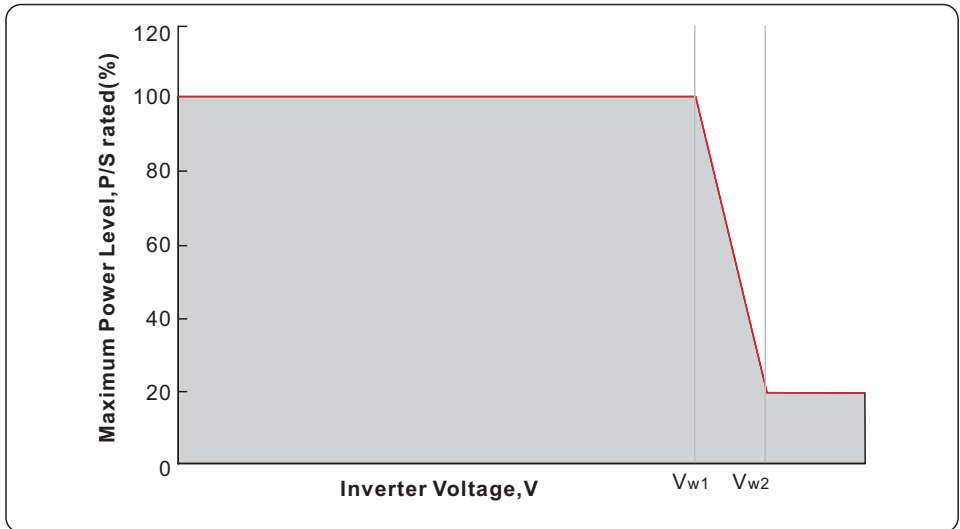

Status: Enable/Disable (Note: This is used to enable or disable the Volt-Watt mode)

Voltage 1: 207V

P-Limit 1: 100%

Voltage 2: 220V

P-Limit 2: 100%

Voltage 3 (Vw1):

235-255V (Default: 4777-A(253V); 4777-B(250V);4777-C(253V);4777-N(242V))

P-Limit 3: 100%

Voltage 4 (Vw2):

240-265V (Default: 4777-A(260V); 4777-B(260V);4777-C(260V);4777-N(250V))

P-Limit 4: 0%-20% (Default: 20% for 4777-A; 4777-B; 4777-C; 4777-N)

3. Q Mode Settings

This Q Mode Settings include 5 working modes:

Disable, Volt-Var, Fixed-PF, Reac-Power, P-factor

3.1 Disable

Description: This mode will disable the reactive power response working modes

3.2 Volt-Var

Description: Inverter will change the reactive output power based on grid voltage.

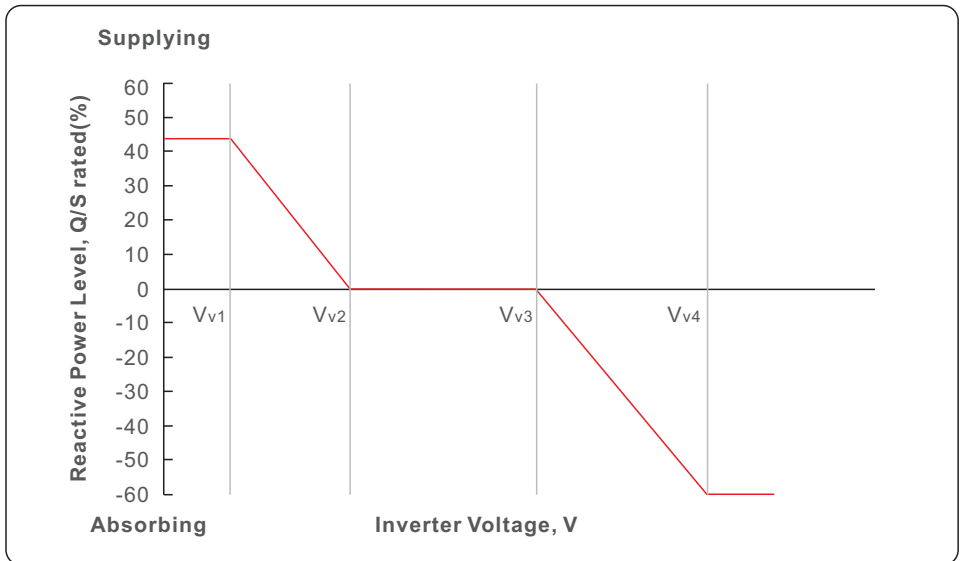

Voltage 1 (Vv1):

180-230V (Default: 4777-A(207V); 4777-B(205V);4777-C(215V);4777-N(207V))

Voltage 2(Vv2) :

180-230V (Default: 4777-A(220V); 4777-B(220V);4777-C(230V);4777-N(220V))

Voltage 3(Vv3) :

230-265V (Default: 4777-A(240V); 4777-B(235V);4777-C(240V);4777-N(235V))

Voltage 4(Vv4) :

230-265V (Default: 4777-A(258V); 4777-B(255V);4777-C(255V);4777-N(244V))

Leading(Supplying) :

+30~+60% (Default: 4777-A(+44%); 4777-B(+30%);4777-C(+44%);4777-N(+60%))

Lagging(Absorbing) :

-30%~-60% (Default: 4777-A(-60%); 4777-B(-40%);4777-C(-60%);4777-N(-60%))

4. Fix PF

Description: This mode is to set a fixed power factor output

Range: -0.8~+0.8

Default: 1

5. Fix Reactive

Description: This mode is to set a fixed reactive power output

Range: -60%~+60%

Default: 0%

6. P-Factor

Description: This mode is not required in Australia.

Solis S6 Series inverter does not require any regular maintenance. However, cleaning the heatsink will help the inverter dissipate heat and increase the lifetime of inverter. The dirt on the inverter can be cleaned with a soft brush.



CAUTION:

Do not touch the surface when the inverter is operating. Some parts may be hot and could cause burns. Turn OFF the inverter and let it cool down before you do any maintenance or cleaning of inverter.

The Screen and the LED status indicator lights can be cleaned with cloth if they are too dirty to be read.



NOTE:

Never use any solvents, abrasives, or corrosive materials to clean the inverter.

6.1 Smart O&M

In order to improve our products and provide you with higher quality services, this device has a built-in data logging module for collecting relevant information during operation (such as power generation data, fault data)

Commitment:

1. We will only collect, use and process your device information for the purpose of improving our products and services.
2. We will take all reasonable and feasible measures to ensure that no irrelevant information is collected and we will protect your device information.
3. We will not share, transfer or disclose the collected device information with any company, organization or individual.
4. When we stop operating products or services, we will stop collecting your device information in a timely manner.
5. If you do not want to provide such information, you can notify our company to turn off this function, which will not affect your normal use of other functions of the product.

Message Name	Information Description	Troubleshooting Suggestion
Off	Control device to shutdown	1. Turn on the device in the ON/OFF Setting.
LmtByEPM	The device's output is under controlled	<ol style="list-style-type: none"> 1. Confirm whether the inverter is connected to an external EPM/meter to prevent reverse current. 2. Confirm whether the inverter is controlled by an external third-party device. 3. Confirm whether the power setting of the inverter power control is limited. 4. Verify settings in section 6.6.7 and check your meter readings.
LmtByDRM	DRM Function ON	1. No need to deal with it.
LmtByTemp	Over temperature power limited	1. No need to deal with it, the device is in normal operation.
LmtByFreq	Frequency power limited	
LmtByVg	The device is in the Volt-Watt mode	<ol style="list-style-type: none"> 1. Due to the requirements of local safety regulations, when the grid voltage is high, the Volt-watt working mode is triggered, which generally does not need to be dealt with. 2. Inverter factory test errors causing this mode to open, if you need to close, you can close this mode in LCD, set the process: Main menu → Advanced Settings → Password 0010 → STD mode settings → Working Mode → Working mode: NULL → Save and exit.
LmtByVar	The device is in the Volt-Var mode of operation	<ol style="list-style-type: none"> 1. Due to the requirements of local safety regulations, when the grid voltage is high, the Volt-watt working mode is triggered, which generally does not need to be dealt with. 2. Inverter factory test errors causing this mode to open, if you need to close, you can close this mode in LCD, set the process: Main menu → Advanced Settings → Password 0010 → STD mode settings → Working Mode → Working mode: NULL → Save and exit.
LmtByUnFr	Under frequency limit	1. No need to deal with it.
Standby	Bypass run	
StandbySynoch	Off grid status to On grid status	
GridToLoad	Grid to load	

Message Name	Information Description	Troubleshooting Suggestion
Surge Alarm	On-site grid surge	1. Grid side fault, restart the device. If it is still not eliminated, please contact the manufacturer's customer service.
OV-G-V01	Grid voltage exceeds the upper voltage range	1. Confirm whether the power grid is abnormal. 2. Confirm that the AC cable is properly connected. 3. Restart the system and check if the fault persists.
UN-G-V01	Grid voltage exceeds the lower voltage range	
OV-G-F01	Grid frequency exceeds the upper frequency range	
UN-G-F01	Grid frequency exceeds the lower frequency range	
G-PHASE	Unbalanced grid voltage	
G-F-GLU	Grid voltage frequency fluctuation	
NO-Grid	No grid	
OV-G-V02	Grid transient overvoltage	
OV-G-V03	Grid transient overvoltage	1. Restart the system, confirm if that the fault continues.
IGFOL-F	Grid current tracking failure	1. Confirm whether the power grid is abnormal. 2. Confirm that the AC cable is properly connected. 3. Restart the system and check if the fault persists.
OV-G-V05	Grid voltage RMS instantaneous overvoltage fault	
OV-G-V04	Grid voltage exceeds the upper voltage range	
UN-G-V02	Grid voltage exceeds the lower voltage range	
OV-G-F02	Grid frequency exceeds the upper frequency range	
UN-G-F02	Grid frequency exceeds the lower frequency range	
NO-Battery	Battery is not connected	1. Check on information page 1 – Verify the battery voltage is within standards. 2. Measure battery voltage at plug.
OV-Vbackup	Inverting overvoltage	1. Check whether the backup port wiring is normal 2. Restart the system, confirm that the fault continues.
Over-Load	Load overload fault	1. Backup load power is too large, or some inductive load startup power is too large, need to remove some backup load, or remove the inductive load on the backup.

Message Name	Information Description	Troubleshooting Suggestion
BatName-FAIL	Wrong battery brand selection	1. Confirm whether the battery model selection is consistent with the actual one.
CAN Fail	CAN Fail	1. Can failure is a failure of communication between inverter and battery. Check cable conditions. Check to ensure you have it plugged in on the CAN port of the battery and inverter. Check that you are using the right cable. Some batteries require a special battery from the battery manufacturer.
OV-Vbatt	Battery undervoltage detected	1. Verify battery voltage is within standards. Measure battery voltage at inverter connection point. Contact your battery manufacturer for further service.
UN-Vbatt	Battery overvoltage detected	1. Restart the system and check if the fault persists. If it is still not eliminated, please contact the manufacturer's customer service.
Fan Alarm	Fan alarm	1. Check if the internal fan is working correctly or jammed.
OV-DC01 (1020 DATA:0001)	DC 1 input overvoltage	1. Check if the PV voltage is abnormal 2. Restart the system, confirm that the fault continues
OV-DC02 (1020 DATA:0002)	DC 2 input overvoltage	
OV-BUS (1021 DATA:0000)	DC bus overvoltage	1. Restart the system, confirm that the fault continues.
UN-BUS01 (1023 DATA:0001)	DC bus undervoltage	
UNB-BUS (1022 DATA:0000)	DC bus unbalanced voltage	
UN-BUS02 (1023 DATA:0002)	Abnormal detection of DC bus voltage	
DC-INTF. (1027 DATA:0000)	DC hardware overcurrent (1, 2, 3, 4)	1. Check if the DC wires are connected correctly without loose connection.
OV-G-I (1018 DATA:0000)	Aphase RMS value overcurrent	1. Confirm that the grid is abnormal. 2. Confirm that the AC cable connection is not abnormal. 3. Restart the system, confirm that the fault continues.
OV-DCA-I (1025 DATA:0000)	DC 1 average overcurrent	1. Restart the system, confirm that the fault continues.
OV-DCB-I (1026 DATA:0000)	DC 2 average overcurrent	
GRID-INTF. (1030 DATA:0000)	AC hardware overcurrent (abc phase)	

7. Troubleshooting

Message Name	Information Description	Troubleshooting Suggestion
DCInj-FAULT (1037 DATA:0000)	The current DC component exceeds the limit	<ol style="list-style-type: none"> 1. Confirm that the grid is abnormal. 2. Confirm that the AC cable connection is not abnormal. 3. Restart the system, confirm that the fault continues.
IGBT-OV-I (1048 DATA:0000)	IGBT overcurrent	<ol style="list-style-type: none"> 1. Restart the system, confirm that the fault continues.
OV-TEM (1032 DATA:0000)	Module over temperature	<ol style="list-style-type: none"> 1. Check whether the surrounding environment of the inverter has poor heat dissipation. 2. Confirm whether the product installation meets the requirements.
RelayChk-FAIL (1035 DATA:0000)	Relay failure	<ol style="list-style-type: none"> 1. Restart the system, confirm that the fault continues.
UN-TEM (103A DATA:0000)	Low temperature protection	<ol style="list-style-type: none"> 1. Check the working environment temperature of the inverter. 2. Restart the system to confirm if the fault continues.
PV ISO-PRO01 (1033 DATA:0001)	PV negative ground fault	<ol style="list-style-type: none"> 1. Check whether the PV strings have insulation problems. 2. Check whether the PV cable is damaged.
PV ISO-PRO02 (1033 DATA:0002)	PV positive ground fault	
12Power-FAULT (1038 DATA:0000)	12V undervoltage failure	<ol style="list-style-type: none"> 1. Check current leakage to ground. Verify your grounding. Verify all wires are in good condition and not leaking current to ground.
ILeak-PRO01 (1034 DATA:0001)	Leakage current failure 01 (30mA)	
ILeak-PRO02 (1034 DATA:0002)	Leakage current failure 02 (60mA)	
ILeak-PRO03 (1034 DATA:0003)	Leakage current failure 03 (150mA)	
ILeak-PRO04 (1034 DATA:0004)	Leakage current failure 04	
ILeak_Check (1039 DATA:0000)	Leakage current sensor failure	
GRID-INTF02 (1046 DATA:0000)	Power grid disturbance 02	<ol style="list-style-type: none"> 1. Confirm whether the grid is seriously distorted. 2. Check whether the AC cable is connected reliably.
OV-Vbatt-H/ OV-BUS-H (1051 DATA:0000)	Battery overvoltage hardware failure / VBUS	<ol style="list-style-type: none"> 1. Check if the battery circuit breaker is tripping. 2. Check if the battery is damaged.

Message Name	Information Description	Troubleshooting Suggestion
OV-ILLC (1052 DATA:0000)	LLC hardware overcurrent	1. Check whether the backup load is overloaded. 2. Restart the system, confirm that the fault continues.
INI-FAULT (1031 DATA:0000)	AD zero drift overlink	1. Restart the system, confirm that the fault continues.
DSP-B-FAULT (1036 DATA:0000)	The master-slave DSP communication is abnormal	
AFCI-Check (1040 DATA:0000)	AFCI self-test failure	
ARC- FAULT (1041 DATA:0000)	AFCI failure	1. Verify connections are tight within your PV system. Arc fault settings can be changed in advanced settings if further adjustment is necessary.

Table 7.1 Fault message and description



NOTE:

If the inverter displays any alarm message as listed in Table 7.1; please turn off the inverter and wait for 5 minutes before restarting it .
If the failure persists, please contact your local distributor or the service center.

Please keep ready with you the following information before contacting us.

1. Serial number of Solis Singles Phase Inverter;
2. The distributor/dealer of Solis Singles Phase Inverter (if available);
3. Installation date.
4. The description of the problem together with necessary information, pictures, attachment.
5. The PV array configuration (e.g. number of panels, capacity of panels, number of strings, etc.);
6. Your contact details.

8. Specifications

Technical Data	S6-EH3P29.9K-H-AU	S6-EH3P30K-H-AU
Input DC (PV side)		
Max Usable PV Input Power	59.8kW	60kW
Recommended Max PV array size	59.8kW	60kW
Max. input voltage	1000V	
Rated voltage	600V	
Start-up voltage	180V	
MPPT voltage range	150-850V	
Full load MPPT voltage range	500-850V	
Max. input current	3*40A	
Max. short circuit current	3*45A	
Max. inverter backfeed current to the array	0A	
MPPT number/Max input strings number	3*6	
Max input power per MPPT	24kW	
Battery		
Battery Type	Li-ion	
Battery Voltage range	150 - 800V	
Max. charge / discharge power	32.1kW	33kW
Max. charge / discharge current	70A*2	
No. of Battery Input	2	
Max. charge / discharge power of each input	32.1kW	33kW
Communication	CAN/RS485	
Input AC (Grid side)		
Max. AC passthrough current	86.4A	86.6A
Rated input voltage	3/N/PE, 230V/400V	
Rated input frequency	50Hz	
Input AC (Generator)		
Max. input power	29.9kW	30kW
Rated input current	43.2A	43.3A
Rated input voltage	3/N/PE, 230V/400V	
Rated input frequency	50Hz	

8. Specifications

Technical Data	S6-EH3P29.9K-H-AU	S6-EH3P30K-H-AU
Output AC(Grid side)		
Rated output power	29.9kW	30kW
Max. apparent output power	29.9kVA	30kVA
Rated grid voltage	3/N/PE, 230V/400V	
The grid voltage range	320-460V	
Relay trip current/Duration	20.8A/10ms	
Rated grid frequency	50Hz	
AC grid frequency range	45-55Hz	
Rated grid output current	43.2A	43.3A
Max. output current	43.2A	43.3A
Inrush current	150A	
Max output fault current	228A@10us	
Max output overcurrent protection	43.2A	43.3A
Power Factor	> 0.99 (0.8 leading - 0.8 lagging)	
Output AC(Back-up)		
Rated output power	29.9kW	30kW
Max. apparent output power	1.6 times of rated power, 2 S	
Back-up switch time	< 10ms	
Rated output voltage	3/N/PE, 230V/400V	
Rated frequency	50 Hz	
Rated. output current	43.2A	43.3A
Max. imbalance power per phase	33% rated power	
THDv(@linear load)	<2%	
Current(Inrush)	150A	
Max output fault current	228A@10us	
Max output overcurrent protection	43.2A	43.3A
Rated apparent power	29.9kVA	30kVA
Efficiency		
Max. efficiency	97.8%	
EU efficiency	97.4%	
BAT charged by PV Max. efficiency	98.5%	
BAT charged/discharged to AC Max. efficiency	97.5%	
MPPT Efficiency	99.9%	

8. Specifications

Technical Data	S6-EH3P29.9K-H-AU	S6-EH3P30K-H-AU
Protection		
Anti-islanding protection	Yes	
Insulation Resistor detection	Yes	
Output over current protection	Yes	
Output short protection	Yes	
Output over voltage protection	Yes	
DC switch	Optional	
DC reverse polarity protection	Yes	
DC Surge Protection/AC Surge Protection	Type II	
Integrated AFCI (DC arc-fault circuit protection)	Optional	
Overvoltage category	PV II, battery II, AC III	
Active anti-islanding method	Active frequency shifting	
Protective class	I	
Inverter topology	non-isolated	
General data		
Dimensions(W/H/D)	530*880*290mm	
Weight	73kg	
Topology	Transformerless	
Self consumption (Night)	<25W	
Operation temperature range	-25°C ~ +60°C	
Relative humidity	0-95%	
Ingress protection	IP66	
THDi	<3%	
Noise emission	<65 dB(A)	
Cooling concept	Intelligent redundant fan-cooling	
Max.operation altitude	4000m	
Grid connection standard	AS/NZS 4777.2:2020	
Safety/EMC standard	IEC 62109-1/-2, IEC 61000-6-2/-4	

8. Specifications

Technical Data	S6-EH3P29.9K-H-AU	S6-EH3P30K-H-AU
Features		
PV connection	MC4 Quick connection plug	
Battery connection	Terminal connector	
AC connection	Terminal Block	
Display	LCD + Bluetooth + APP	
Communication	CAN, RS485, Ethernet, Optional:Wi-Fi, Cellular, LAN	
Warranty	5 years (Extendable to 20 years)	

8. Specifications

Technical Data	S6-EH3P40K-H-AU	S6-EH3P50K-H-AU
Input DC (PV side)		
Max Usable PV Input Power	80kW	96kW
Recommended Max PV array size	80kW	100kW
Max. input voltage	1000V	
Rated voltage	600V	
Start-up voltage	180V	
MPPT voltage range	150-850V	
Full load MPPT voltage range	500-850V	600-850V
Max. input current	4*40A	
Max. short circuit current	4*45A	
Max. inverter backfeed current to the array	0A	
MPPT number/Max input strings number	4*8	
Max input power per MPPT	24kW	
Battery		
Battery Type	Li-ion	
Battery Voltage range	150 - 800V	
Max. charge / discharge power	44kW	55kW
Max. charge / discharge current	70A*2	
No. of Battery Input	2	
Max. charge / discharge power of each input	35kW	35kW
Communication	CAN/RS485	
Input AC (Grid side)		
Max. AC passthrough current	115.4A	144.4A
Rated input voltage	3/N/PE, 230V/400V	
Rated input frequency	50Hz	
Input AC (Generator)		
Max. input power	40kW	50kW
Rated input current	57.7A	72.2A
Rated input voltage	3/N/PE, 230V/400V	
Rated input frequency	50Hz	

8. Specifications

Technical Data	S6-EH3P40K-H-AU	S6-EH3P50K-H-AU
Output AC(Grid side)		
Rated output power	40kW	50kW
Max. apparent output power	40kVA	50kVA
Rated grid voltage	3/N/PE, 230V/400V	
The grid voltage range	320-460V	
Relay trip current/Duration	20.8A/10ms	
Rated grid frequency	50Hz	
AC grid frequency range	45-55Hz	
Rated grid output current	57.7A	72.2A
Max. output current	57.7A	72.2A
Inrush current	150A	
Max output fault current	228A@10us	
Max output overcurrent protection	57.7A	72.2A
Power Factor	> 0.99 (0.8 leading - 0.8 lagging)	
Output AC(Back-up)		
Rated output power	40kW	50kW
Max. apparent output power	1.6 times of rated power, 2 S	
Back-up switch time	< 10ms	
Rated output voltage	3/N/PE, 230V/400V	
Rated frequency	50 Hz	
Rated. output current	57.7A	72.2A
Max. imbalance power per phase	33% rated power	
THDv(@linear load)	<2%	
Current(Inrush)	150A	
Max output fault current	228A@10us	
Max output overcurrent protection	57.7A	72.2A
Rated apparent power	40kVA	50kVA
Efficiency		
Max. efficiency	97.8%	
EU efficiency	97.4%	
BAT charged by PV Max. efficiency	98.5%	
BAT charged/discharged to AC Max. efficiency	97.5%	
MPPT Efficiency	99.9%	

8. Specifications

Technical Data	S6-EH3P40K-H-AU	S6-EH3P50K-H-AU
Protection		
Anti-islanding protection	Yes	
Insulation Resistor detection	Yes	
Output over current protection	Yes	
Output short protection	Yes	
Output over voltage protection	Yes	
DC switch	Optional	
DC reverse polarity protection	Yes	
DC Surge Protection/AC Surge Protection	Type II	
Integrated AFCI (DC arc-fault circuit protection)	Optional	
Overvoltage category	PV II, battery II, AC III	
Active anti-islanding method	Active frequency shifting	
Protective class	I	
Inverter topology	non-isolated	
General data		
Dimensions(W/H/D)	530*880*290mm	
Weight	73kg	
Topology	Transformerless	
Self consumption (Night)	<25W	
Operation temperature range	-25°C ~ +60°C	
Relative humidity	0-95%	
Ingress protection	IP66	
THDi	<3%	
Noise emission	<65 dB(A)	
Cooling concept	Intelligent redundant fan-cooling	
Max.operation altitude	4000m	
Grid connection standard	AS/NZS 4777.2:2020	
Safety/EMC standard	IEC 62109-1/-2, IEC 61000-6-2/-4	

8. Specifications

Technical Data	S6-EH3P40K-H-AU	S6-EH3P50K-H-AU
Features		
PV connection	MC4 Quick connection plug	
Battery connection	Terminal connector	
AC connection	Terminal Block	
Display	LCD + Bluetooth + APP	
Communication	CAN, RS485, Ethernet, Optional:Wi-Fi, Cellular, LAN	
Warranty	5 years (Extendable to 20 years)	

Frequently Asked Questions

Q1: Why I have "CAN Fail" Alarm on the inverter?

A: "CAN Fail" indicates the CAN communication between inverter and battery is lost. Please double check if your CAN cable is correctly connected and if your battery is power on.

Q2: Why I have "BATName-Fail" Alarm on the inverter ?

A: Please check in the "Battery Setting->Battery Model" setting and confirm you selected the correct battery option as the nameplate of your battery module.

Q3: Why I have "MET-SLT-Fail" Alarm on the inverter?

A: Please check in the "Meter Setting->Meter Type" setting and confirm you selected the correct meter option corresponding to your smart meter.

Q4: Why the power values on the screen are fluctuating very fast?

A: If your loads are changing drastically, the inverter will adjust its power accordingly. If you confirm the loads are stable while the inverter power is changing very fast, please double check your meter CT's direction and make sure the arrow is towards grid.

Q5: Why I have "OV-ILLC" Alarm on the inverter ?

A: OV-ILLC indicates there is an overcurrent issue on the internal LLC circuit. It could be transient status during extreme condition such as overload. If it happens constantly or too frequent and the extreme conditions have been excluded, please contact Solis service team.

Q6: Why I have "OV-BATT-H" Alarm on the inverter ?

A: OV-BATT-H indicates over voltage issue on the hardware of battery circuit. It could be caused by high battery voltage at full SOC, battery suddenly switching off, etc. If it happens constantly or too frequent and the extreme conditions have been excluded, please contact Solis service team.

Q7: Why I have "No-Battery" Alarm on the inverter?

A: Please double check if the battery power cables have been correctly connected and the battery breaker (on battery or external) has been turn on. If you don't want to connect the battery for now, please select the "No battery" option in "Battery Setting->Battery Model" to prevent the alarm to show up.

Ginlong Technologies Co., Ltd.

No. 57 Jintong Road, Binhai Industrial Park, Xiangshan, Ningbo,
Zhejiang, 315712, P.R.China.

Tel: +86 (0)574 6578 1806

Email: info@ginlong.com

Web: www.solisinverters.au

Please adhere to the actual products in case of any discrepancies in this user manual.

If you encounter any problem on the inverter, please find out the inverter S/N and contact us, we will try to respond to your question ASAP.