



User Manual

for S6 Series Hybrid Inverter



Applicable models

S6-EH1P3K-L-AU

S6-EH1P3.6K-L-AU

S6-EH1P4.6K-L-AU

S6-EH1P5K-L-AU

S6-EH1P6K-L-AU

Applicable System

Single phase system

1. Introduction	02
1.1 Product Description	02
1.2 Packaging	03
2. Safety & Warning	04
2.1 Safety	04
2.2 General Safety Instructions	04
2.3 Notice For Use	06
2.4 Notice for Disposal	06
3. Overview	07
3.1 Intelligent LED Indicators	07
4. Installation	08
4.1 Select a Location for the Inverter	08
4.2 Mounting the Inverter	09
4.3 PE Cable Installation	11
4.4 PV Input Cable Installation	12
4.5 Battery Power Cable Installation	15
4.6 AC Cable Installation	16
4.7 Communication Cable Installation	18
4.8 Meter Installation	23
4.9 Inverter Remote Monitoring Connection	25
4.10 External Residual Current Device(RCD)	26
4.11 Max over current protection device (OCPD)	26
4.12 Earth Fault Alarm	26
5. Commissioning	27
5.1 Preparation	27
5.2 APP Download	27
6. Operation	28
6.1 Power On	28
6.2 Log in the APP via bluetooth	29
6.3 Initial Set Up	30
6.4 Startup procedure	45
6.5 Shutdown procedure	45
6.6 Australian Grid Code Settings	46
6.7 Export Power Control	50
7. Maintenance	51
8. Troubleshooting	52
9. Specifications	57
10. Appendix	66

1.1 Product Description

The Solis S6-EH1P-L Series is designed for residential hybrid systems, which can work with batteries to optimize self-consumption. The unit can operate in both off-grid and on-grid modes.

This manual covers the Solis S6-EH1P-L Series model listed below:

S6-EH1P3K-L-AU, S6-EH1P3.6K-L-AU, S6-EH1P4.6K-L-AU,
S6-EH1P5K-L-AU, S6-EH1P6K-L-AU

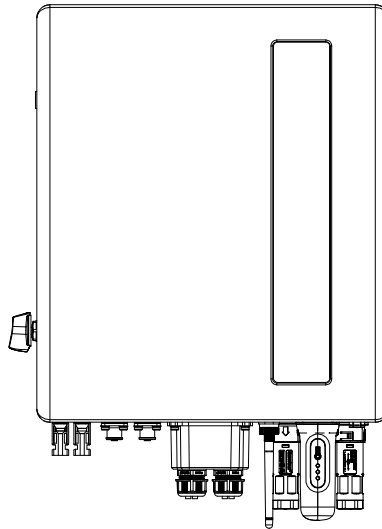

Figure 1.1 Front side view

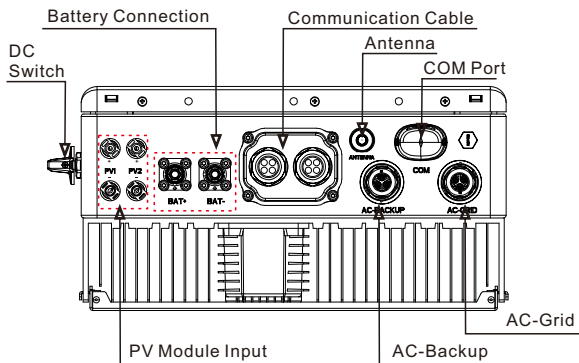
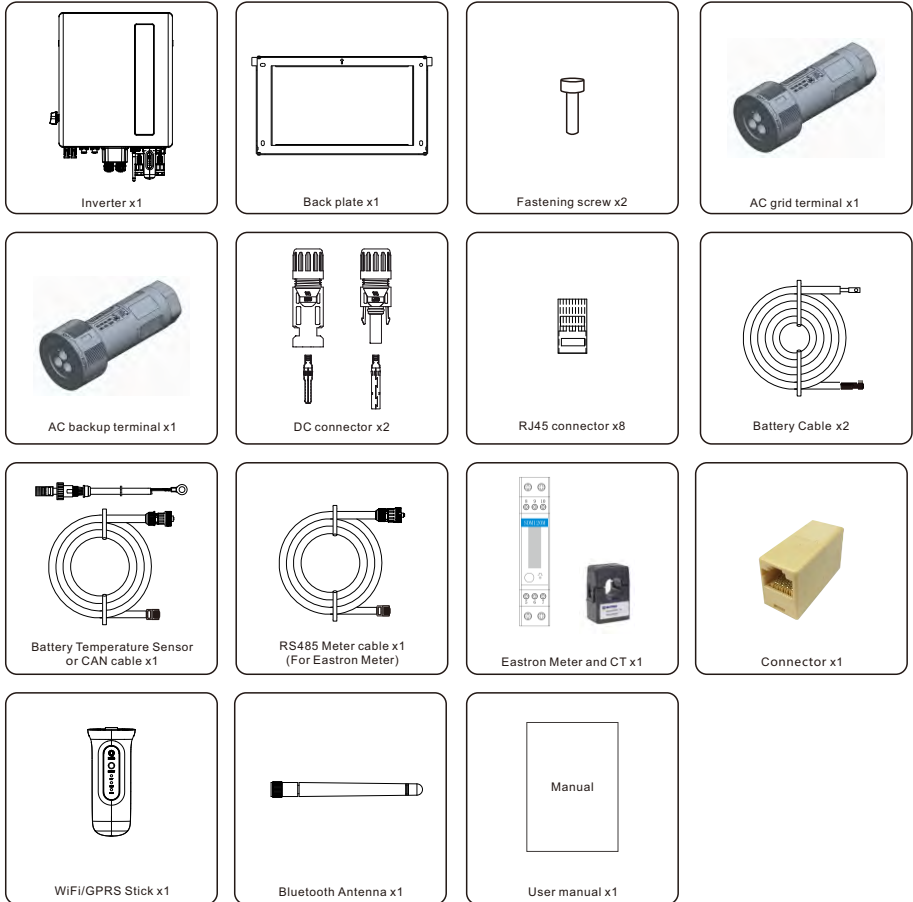

Figure 1.2 Bottom side view

1.2 Packaging

Please ensure that the following items are included in the packaging with your machine:



If anything is missing, please contact your local Solis distributor.

2.1 Safety

The following types of safety instructions and general information appear in this document as described below:



DANGER:

“Danger” indicates a hazardous situation which if not avoided, will result in death or serious injury.



WARNING:

“Warning” indicates a hazardous situation which if not avoided, could result in death or serious injury.



CAUTION:

“Caution” indicates a hazardous situation which if not avoided, could result in minor or moderate injury.



NOTE:

“Note” provides tips that are valuable for the optimal operation of your product.



WARNING: Risk of fire

Despite careful construction, electrical devices can cause fires.

- Do not install the inverter in areas containing highly flammable materials or gases.
- Do not install the inverter in potentially explosive atmospheres.

2.2 General Safety Instructions



WARNING:

Only devices in compliance with SELV (EN 69050) may be connected to the RS485 and USB interfaces.



WARNING:

Please don't connect PV array positive (+) or negative (-) to ground, it could cause serious damage to the inverter.



WARNING:

Electrical installations must be done in accordance with the local and national electrical safety standards.



WARNING:

Do not touch any inner live parts until 5 minutes after disconnection from the utility grid and the PV input.



WARNING:

To reduce the risk of fire, over-current protective devices (OCPD) are required for circuits connected to the inverter.

The DC OCPD shall be installed per local requirements. All photovoltaic source and output circuit conductors shall have isolators that comply with the NEC Article 690, Part II.

All Solis single phase inverters feature an integrated DC switch.



CAUTION:

Risk of electric shock, do not remove cover. There is no user serviceable parts inside, refer servicing to qualified and accredited service technicians.



CAUTION:

The PV array supplies a DC voltage when they are exposed to sunlight.



CAUTION:

Risk of electric shock from energy stored in capacitors of the Inverter, do not remove cover for 5 minutes after disconnecting all power sources (service technician only). Warranty may be voided if the cover is removed without authorization .



CAUTION:

The surface temperature of the inverter can reach up to 75 °C (167 F). To avoid risk of burns, do not touch the surface of the inverter while it's operating. Inverter must be installed out of the reach of children.



NOTE:

PV module used with inverter must have an IEC 61730 Class A rating.



WARNING:

Operations below must be accomplished by licensed technician or Solis authorized person.



WARNING:

Operator must put on the technicians' gloves during the whole process in case of any electrical hazards.



WARNING:

AC BACKUP Port of S6-EH1P-L Series is not allowed to connect to the grid.



WARNING:

The S6-EH1P-L Series does not support parallel in three phase operation on the AC-BACKUP port.

The inverter support parallel in single phase and support generator.
(Only for 4.6/5/6kW)

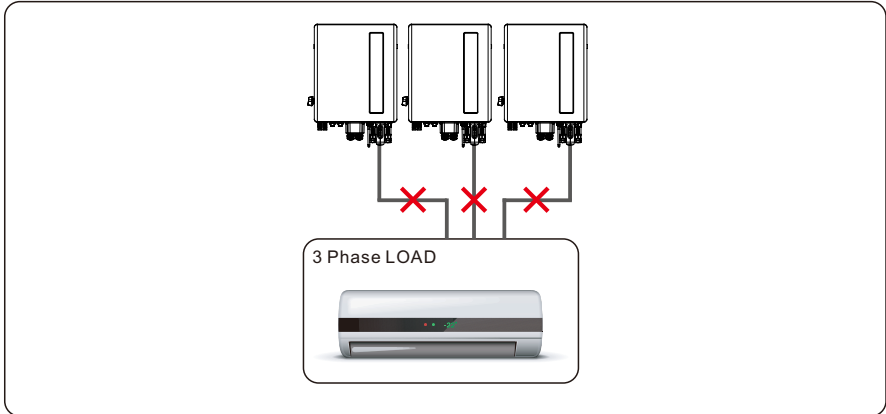

WARNING:

Please refer to the specification of the battery before configuration.

2.3 Notice For Use

The inverter has been constructed according to the applicable safety and technical guidelines. Use the inverter in installations that meet the following specifications ONLY:

1. Permanent installation is required.
2. The electrical installation must meet all the applicable regulations and standards.
3. The inverter must be installed according to the instructions stated in this manual.
4. The inverter must be installed according to the correct technical specifications.

2.4 Notice for Disposal

This product shall not be disposed of with household waste.

They should be segregated and brought to an appropriate collection point to enable recycling and avoid potential impacts on the environment and human health.





Local rules in waste management shall be respected .



3.1 Intelligent LED Indicators

There are five indicators on the The Solis S6-EH1P(3-6)K-L Series Inverter (Battery, Power, WiFi, Ethernet and Bluetooth) which indicate the working status of the inverter.

The Bluetooth Antenna or WiFi datalogger shall be installed at the Antenna/COM port of the hybrid inverter before local debugging.

Light	Status	Description
 Battery	Blue Flashing every 3s	Battery discharging.
	Blue Flashing every 1.5s	Battery charging.
	Blue Solid ON	Idle.
	Yellow Solid ON	Battery Warning.
 Power	Blue Solid ON	Normally Operating.
	Yellow Solid ON	Warning.
	Red Solid ON	Alarm.
 WiFi	Blue Solid ON	COM Port is using.
	OFF	COM Port is not used.
 RS485	Blue Solid ON	RS485 Port is using.
	OFF	RS485 Port is not used.
 Bluetooth	Blue Solid ON	Bluetooth Port is using.
	OFF	Bluetooth Port is not used.



NOTE: Battery/WiFi/Ethernet/Bluetooth indicators will automatically turn off after 1 minute. The Power indicator will remain on with lower brightness. Short press the Power indicator can wake up all indicators.

4.1 Select a Location for the Inverter

To select a location for the inverter, the following criteria should be considered:

- Exposure to direct sunlight may cause output power derating. It is recommended to avoid installing the inverter in direct sunlight.
- It is recommended that the inverter is installed in a cooler ambient which doesn't exceed 104°F/40°C.

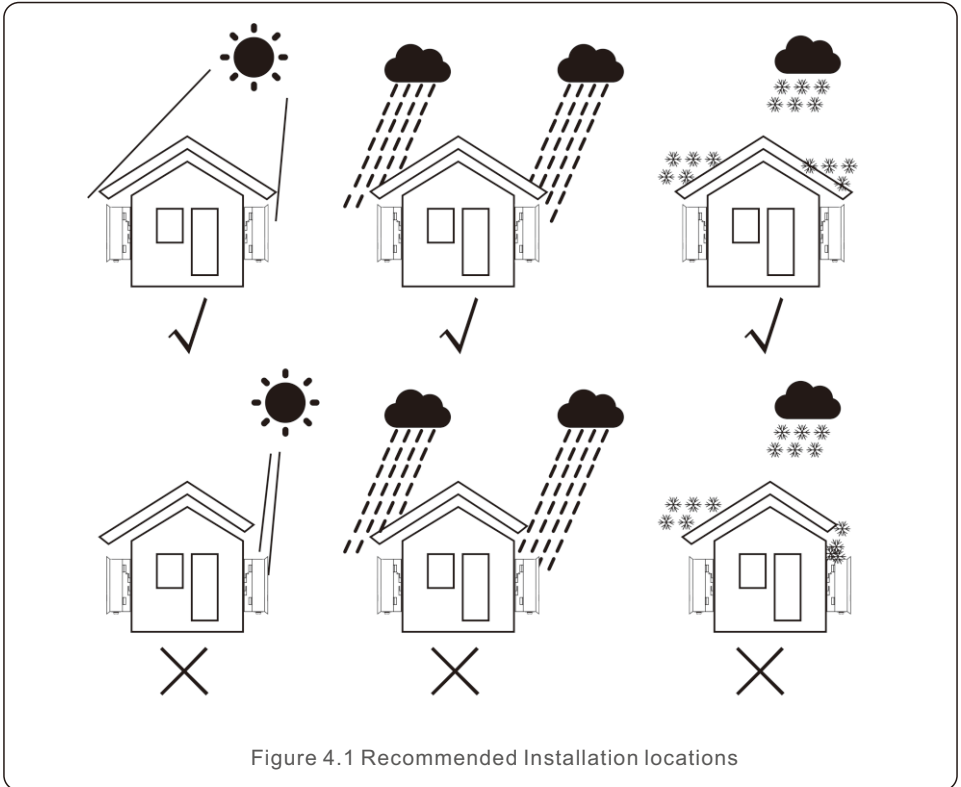

Figure 4.1 Recommended Installation locations



WARNING: Risk of fire

Despite careful construction, electrical devices can cause fires.

- Do not install the inverter in areas containing highly flammable materials or gases.
- Do not install the inverter in potentially explosive atmospheres.
- The mounting structure where the inverter is installed must be fireproof.

- Install on a wall or strong structure capable of bearing the weight of the machine (24.18kg).
- Install vertically with a maximum incline of +/- 5 degrees, exceeding this may cause output power derating.
- To avoid overheating, always make sure the flow of air around the inverter is not blocked. A minimum clearance of 400mm should be kept between inverters or objects and 800mm clearance between the bottom of the machine and the ground.

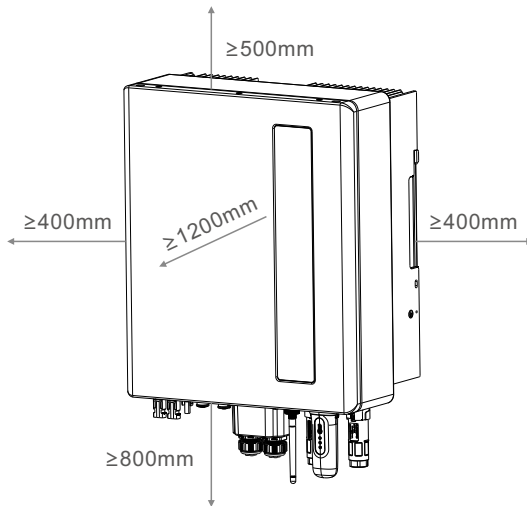

Figure 4.2 Inverter Mounting clearance

- Adequate ventilation must be provided.



NOTE:

Nothing should be stored on or placed against the inverter.

4.2 Mounting the Inverter

Dimensions of mounting bracket:

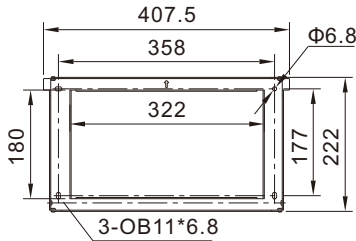

unit:mm

Figure 4.3 Inverter wall mounting

Once a suitable location has been found according to 4.1 using figure 4.3 mount the wall bracket to the wall.

The inverter shall be mounted vertically.

The steps to mount the inverter are listed below:

1. Select the mounting height of the bracket and mark the mounting holes.

For brick walls, the position of the holes should be suitable for the expansion bolts.

2. Lift up the inverter (be careful to avoid body strain), and align the back bracket on the inverter with the convex section of the mounting bracket. Hang the inverter on the mounting bracket and make sure the inverter is secure (see Figure 4.4)

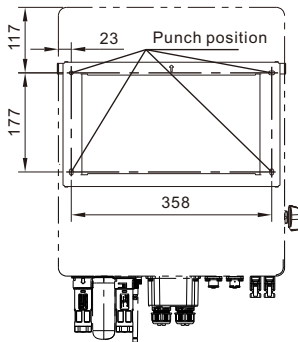
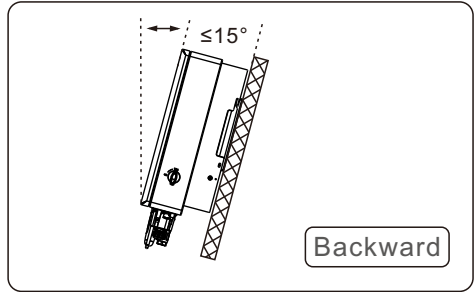
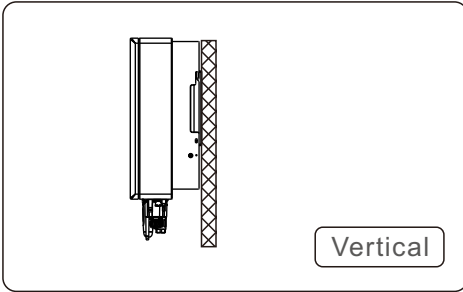

Figure 4.4 Wall Mount Bracket



WARNING:

The inverter must be mounted vertically.



- Install vertically (+/- 5°) or tilted backward ($\leq 15^\circ$).
- Don't mount inverter on the tilted forward wall.
- Don't mount inverter on the horizontal.

4.3 PE Cable Installation

An external ground connection is provided at the right side of inverter.

Prepare OT terminals: M4. Use proper tooling to crimp the lug to the terminal.

Connect the OT terminal with ground cable to the right side of inverter. The torque is 2N.m.

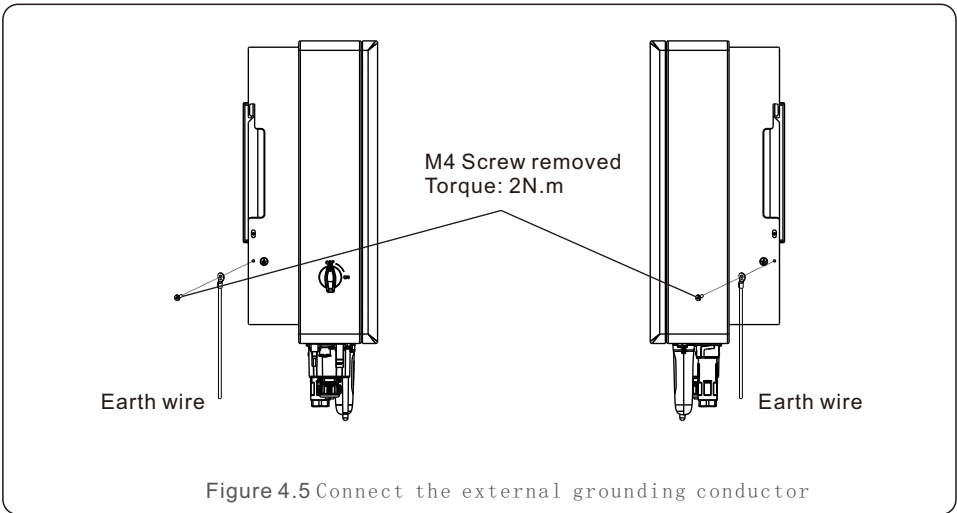

4.4 PV Input Cable Installation



Before connecting inverter, please make sure the PV array open circuit voltage is within the limit of the inverter.



Before connection, please make sure the polarity of the output voltage of PV array matches the "DC+" and "DC-" symbols.



Please use approved DC cable for PV system.

1. Select a suitable DC cable and strip the wires out by $7\pm 0.5\text{mm}$. Please refer to the table below for specific specifications.

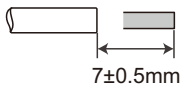

Cable type	Cross section (mm ²)	
	Range	Recommended value
Industry generic PV cable	4.0~6.0 (12~10AWG)	4.0 (12AWG)

Figure 4.6

2. Take the DC terminal out of the accessory bag, turn the screw cap to disassemble it, and take out the waterproof rubber ring.

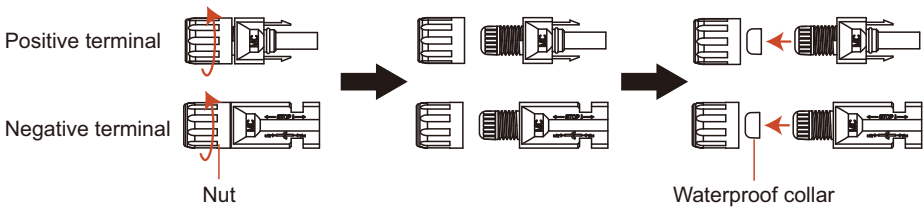
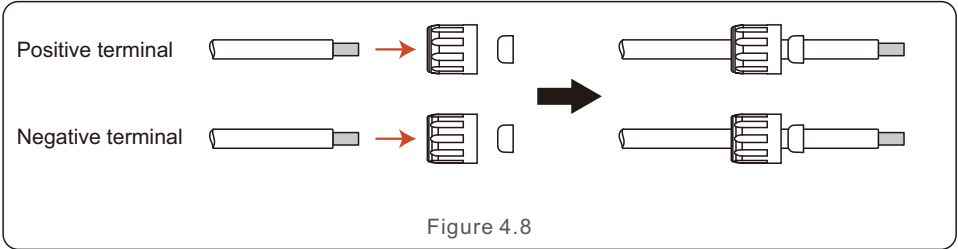
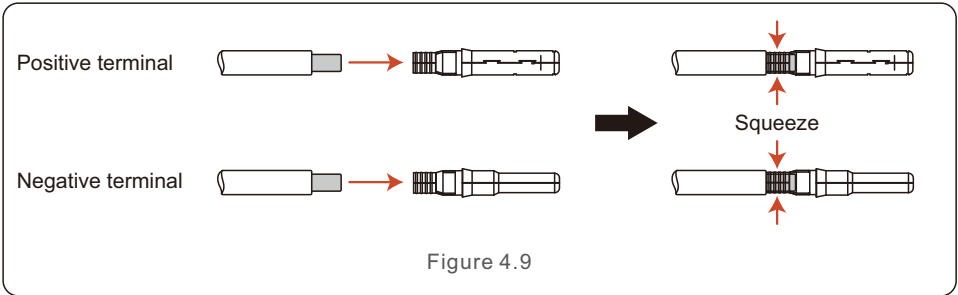

Figure 4.7

3. Pass the stripped DC cable through the nut and waterproof rubber ring.



4. Connect the wire part of the DC cable to the metal DC terminal and crimp it with a special DC terminal crimping tool.



5. Insert the crimped DC cable into the DC terminal firmly, then insert the waterproof rubber ring into the DC terminal and tighten the nut.

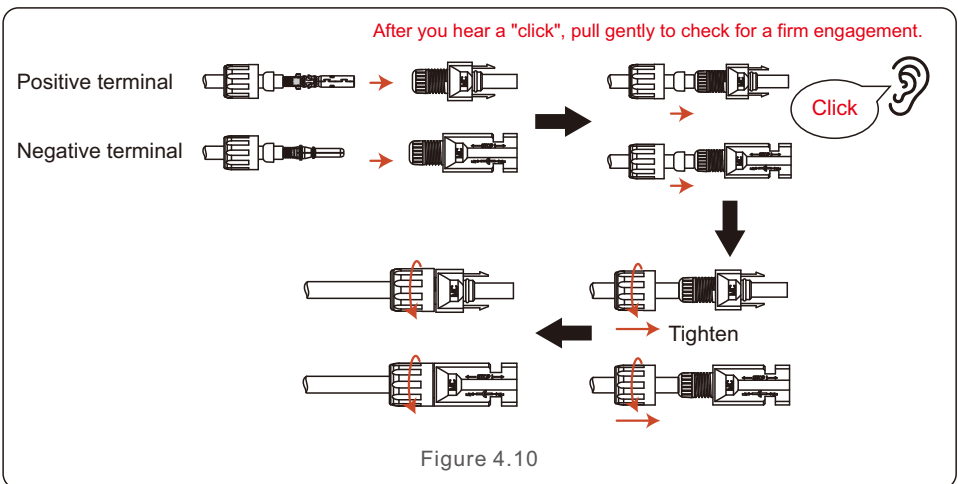

6. Measure PV voltage of DC input with multimeter, verify DC input cable polarity.

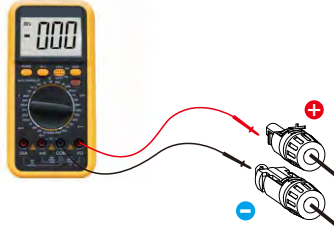

Figure 4.11

7. Connect the wired DC terminal to the inverter as shown in the figure, and a slight "click" is heard to prove the connection is correct.

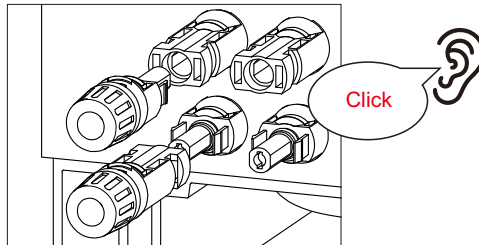

Figure 4.12



CAUTION:

If DC inputs are accidentally reversely connected or inverter is faulty or not working properly, it is NOT allowed to turn off the DC switch. Otherwise it may cause DC arc and damage the inverter or even lead to a fire disaster. The correct actions are:

*Use a clip-on ammeter to measure the DC string current.

*If it is above 0.5A, please wait for the solar irradiance reduces until the current decreases to below 0.5A.

*Only after the current is below 0.5A, you are allowed to turn off the DC switches and disconnect the PV strings.

* In order to completely eliminate the possibility of failure, please disconnect the PV strings after turning off the DC switch to avoid secondary failures due to continuous PV energy on the next day.

Please note that any damages due to wrong operations are not covered in the device warranty.

4.5 Battery Power Cable Installation



NOTE:

1. The positive wiring (the angle of the limit tip is 90°) is connected to the positive socket, and the negative wiring (the angle of the limit tip is 180°) is connected to the negative socket;
2. When the terminal is inserted into the corresponding socket, you need to press the circular button on the terminal lightly and pay attention to the direction of the limit pin and the socket slot.

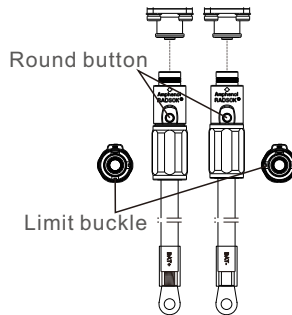
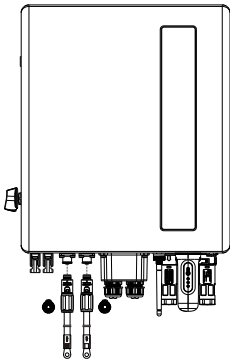

Figure 4.13

4.6 AC Cable Installation

There are two AC terminals and the assembly steps for both are the same.
Take out the AC connector parts from the packaging.

Describe	Numerical value
Cable diameter	10~14mm
Traverse cross sectional area	6~8mm ²
Exposure Length	9mm

Table 4.1

1. Disassemble the AC connector. Strip the AC wires about 9mm.

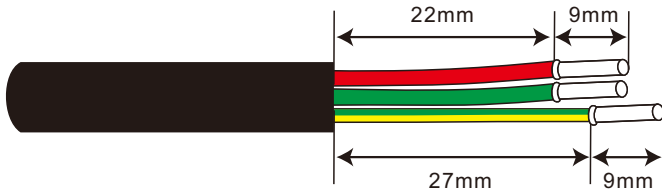
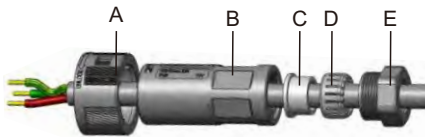

Figure 4.14

2. Set the parts on the cable.



A: Locker
B: Body
C: Seal body
D: Claw
E: Nut

Figure 4.15

3. Crimp wires screw twisting torque 0.8+/-0.1N·m.

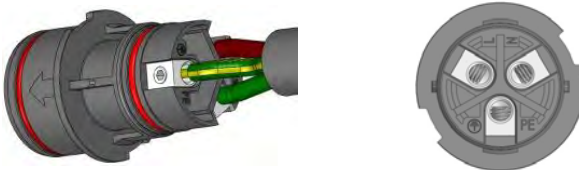

Figure 4.16

4. Push Housing into Body.



Figure 4.17

5. Insert Seal and Clamp Finger into socket ,then tighten the nut , torque 4+/-0.5N·m.



Figure 4.18

6. The same installation for both cable end plug and socket connectors.

7. Mating plug and socket: Push the plug into the socket completely, then rotate the locker according to the direction instructed by the marks on the locker.

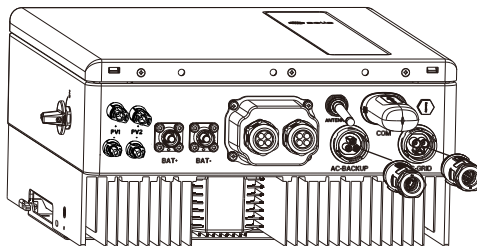

Figure 4.19



NOTE:

Before mating the plug and socket, please double check both AC Grid and AC Backup connectors. Do not connect the grid cables to the AC Backup port or connect the backup load cables to the AC Grid Port. Otherwise, it may leads to malfunction or damage.

4.7 Communication Cable Installation

4.7.1 Protective Cover for Communication Ports

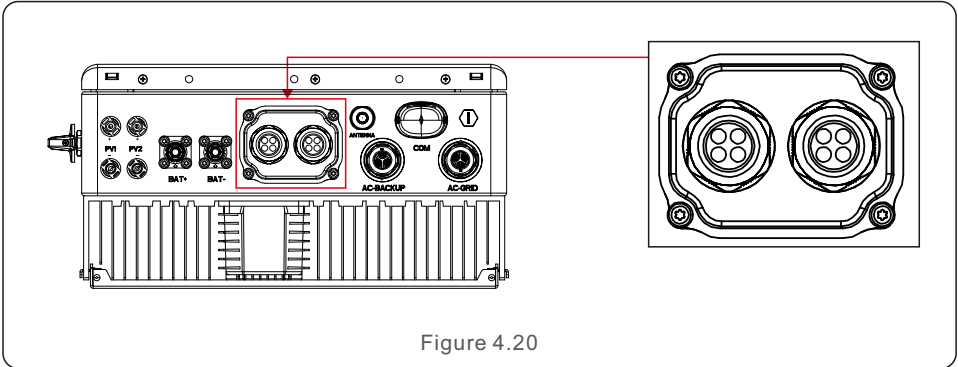

Figure 4.20

Inverter in the package is with a protective cover assembled to protect the communication ports.

Step 1. Use Phillips screwdriver to take out the 4 screws on the cover.

Step 2. Read through the following sections of the manual and prepare the internet cables correspondingly.

Step 3. Loose the cable gland and remove the watertight caps inside the cable gland based on the number of the cables and keep the unused holes with watertight cap.

Step 4. Lead the cables into the holes in the cable gland. (Hole Diameter: 6mm)

Step 5. Crimp the RJ45 connectors onto the cables according to the pin definitions described in the following sections and connect to the ports accordingly.

Step 6. Fasten the 4 screws on the cover (Torque: 1.7N.m-2 N.m)

Step 7. Reassemble the cable gland and ensure there is no bending or stretching of the internet cables inside the cover.



NOTE:

The 4-hole fastening rings inside the cable gland are with openings on the side. Please separate the gap with hand and squeeze the cables into the holes from the side openings.

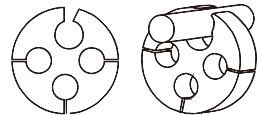

4.7.2 Communication Port Definition

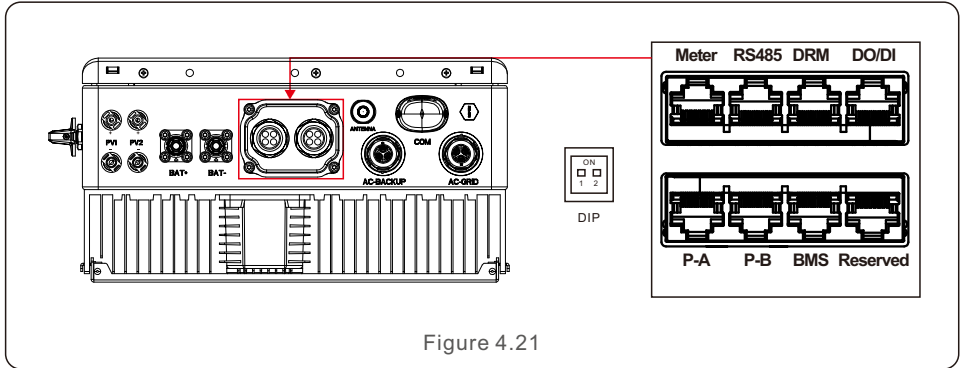

Figure 4.21

Port	Function
BMS	Used for CAN communication between inverter and Lithium battery BMS.
Meter	Used for RS485 communication between inverter and the smart meter. It is necessary to realize the normal hybrid control logics.
DRM	(Optional)To realize Demand Response or Logic interface function, this function may be required in UK and Australia.
RS485	(Optional) Used for Modbus RTU communication with 3rd party external device or controller.
P-A/P-B	(Optional) Parallel operation communication ports (Reserved).
DO/DI	(Optional) Dry contact port (Reserved).
DIP Switch	When a single inverter is running, Pin1&Pin2 are placed in the OFF position, and when multiple inverters are paralleled, refer to the parallel manual for DIP switch settings.

Table 4.3

4.7.3 BMS Port Connection

Take out the pre-made CAN cable from the package and connect one end to battery CAN port and then connect another end to the inverter BMS port. Cable Length: 3 meters.



Figure 4.22



NOTE:

Before connecting CAN cable with the battery, please check whether the communication pin sequence of the inverter and the battery match; If it does not match, you need to cut off the RJ45 connector at one end of the CAN cable and adjust the pin sequence according to the pin definitions of both inverter and battery.

Pin definition of the inverter CAN Port is following EIA/TIA 568B.

CAN-H on Pin 4: Blue

CAN-L on Pin 5: Blue/White

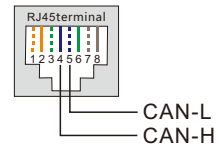

4.7.4 Meter Port Connection

Take out the pre-made Meter cable from the package and connect RJ45 end to inverter Meter port and then connect another end with loose RS485 A & B pins to the meter RS485 terminal. Cable Length: 5 meters.

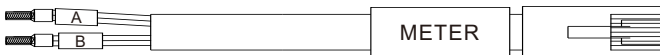

Figure 4.23



NOTE:

Pin definition of the Meter Port is following EIA/TIA 568B.

RS485A on Pin 1: Orange/white

RS485B on Pin 2: Orange

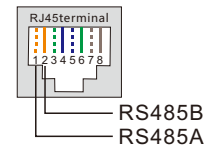

NOTE:

Compatible Smart Meter Pin definition.

Eastron SDM630MCT – Pin 13 is RS485B & Pin 14 is RS485A.

Eastron SDM630 – Pin B is RS485B & Pin A is RS485A.

4.7.5 DRM Port Connection (Optional)

4.7.5.1 For Remote Shutdown Function

Solis inverters support remote shutdown function to remotely control the inverter to power on and off through logic signals.

The DRM port is provided with an RJ45 terminal and its Pin5 and Pin6 can be used for remote shutdown function.

Signal	Function
Short Pin5 and Pin6	Inverter Generates
Open Pin5 and Pin6	Inverter Shutdown in 5s

Table 4.2

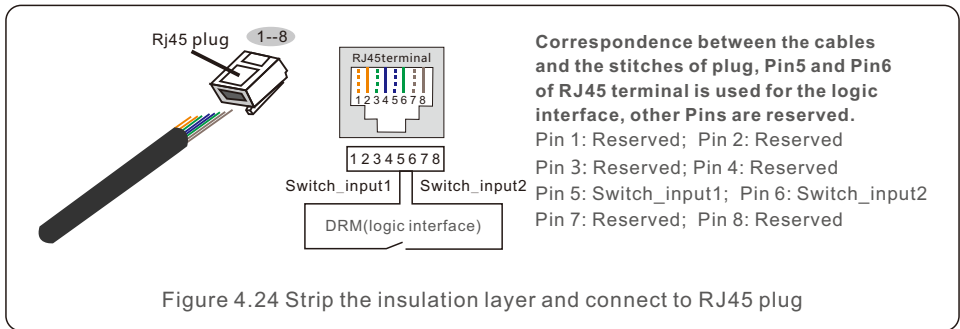

Figure 4.24 Strip the insulation layer and connect to RJ45 plug

4.7.5.2 For DRED Control Function (For AU and NZ Only)

DRED means demand response enable device. The AS/NZS 4777.2:2020 required inverter need to support demand response mode(DRM).

This function is for inverter that comply with AS/NZS 4777.2:2020 standard.

A RJ45 terminal is used for DRM connection.

Pin	Assignment for inverters capable of both charging and discharging	Pin	Assignment for inverters capable of both charging and discharging
1	DRM 1/5	5	RefGen
2	DRM 2/6	6	Com/DRM0
3	DRM 3/7	7	V+
4	DRM 4/8	8	V-

Table 4.5



NOTE:

Solis hybrid inverter is designed to provide 12V power for DRED.

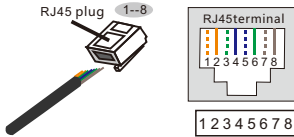

Correspondence between the cables and the stitches of plug

- Pin 1: white and orange ; Pin 2: orange
- Pin 3: white and green; Pin 4: blue
- Pin 5: white and blue; Pin 6: green
- Pin 7: white and brown; Pin 8: brown

Figure 4.25 Strip the insulation layer and connect to RJ45 plug

4.7.6 RS485 Port Connection (Optional)

If a 3rd party external device or controller needs to communicate with the inverter, the RS485 port can be used. Modbus RTU protocol is supported by Solis inverters. To acquire latest protocol document, please contact Solis local service team or Solis sales.



NOTE:

Pin definition of the RS485 Port is following EIA/TIA 568B.

- RS485A on Pin 5: Blue/White
- RS485B on Pin 4: Blue

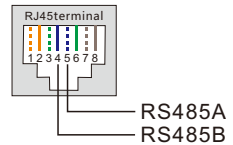

4.8 Meter Installation



CAUTION:

Make sure the AC cable is totally isolated from AC power before connecting the Smart Meter and CT.

A Smart Meter with the CT in product box is compulsory for hybrid system installation. It can be used to detect the grid voltages and current directions, provide the operating condition of the hybrid inverter via RS485 communications.



NOTE:

1. The Smart Meter with CT is already configured ; please do not change any settings on the Smart Meter.
2. One Smart Meter can be used with only one hybrid inverter.

The Solis S6-EH1P-L Series inverter is able to connected Acrel meters or Eastron meters to fulfill the control logic of the self-consumption mode, export power control, monitoring, etc.

Eastron 1ph meter (With CT): SDM120CTM

Meter RS485 Pin Definition: Pin 9 – RS485B, Pin 10 – RS485A

Below 4.8.1 section describes the connection diagram of 1ph meter Eastron SDM120CTM.



NOTE:

Please note that the CT orientation must be correct, otherwise the system will not work properly.



4.8.1 Single phase meter installation

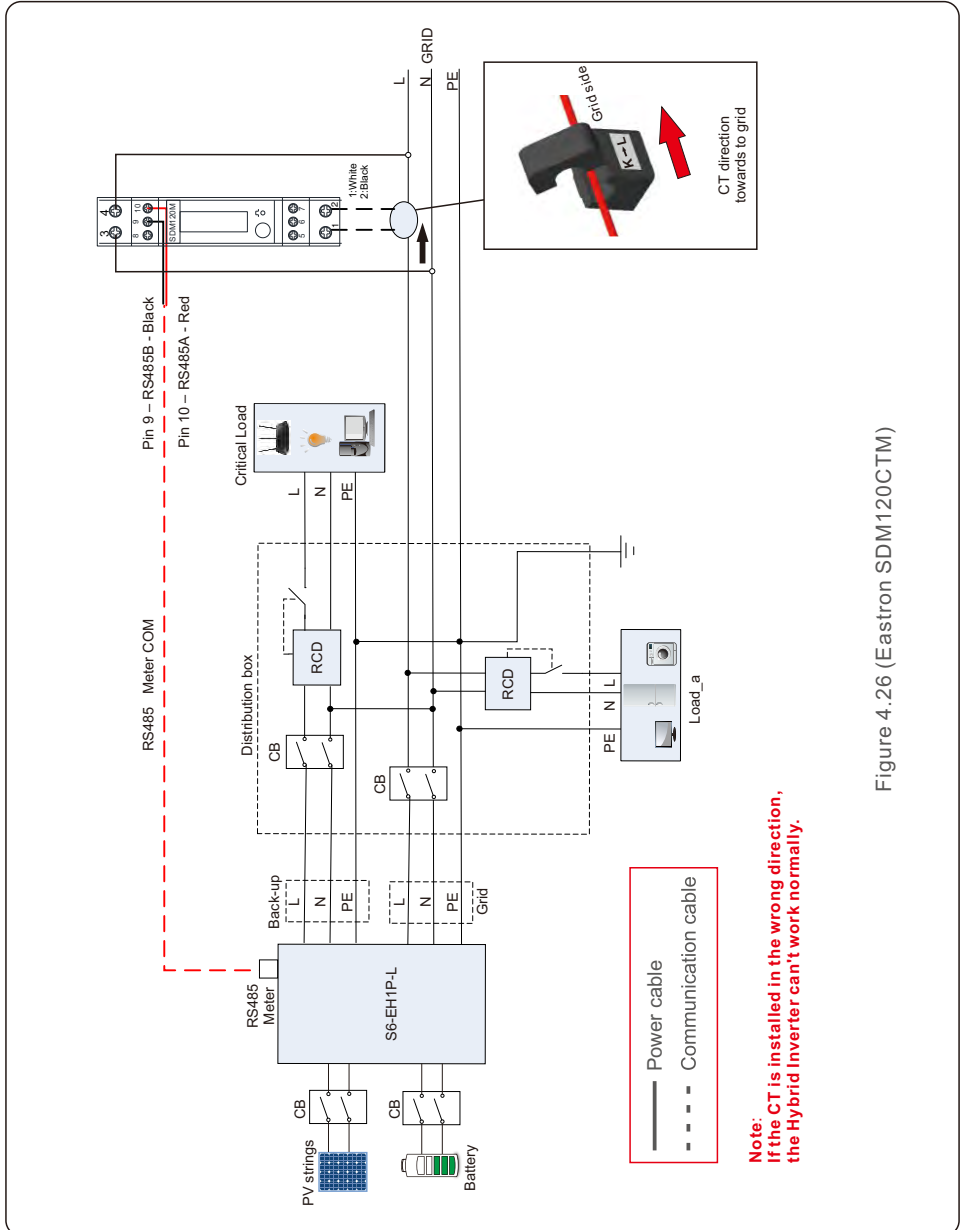

Figure 4.26 (Eastron SDM120CTM)

4.9 Inverter Remote Monitoring Connection

The inverter can be remotely monitored via WiFi, LAN or 4G.

The USB type COM port at the bottom of the inverter can connect to different kinds of Solis data loggers to realize the remote monitoring on Soliscloud platform.

To install Solis data loggers, please refer to corresponding user manuals of Solis data loggers.

The Solis data loggers are optional and can be purchased separately.

Dust cover is provided the inverter package in case the port is not used.



WARNING:

The USB type COM port is only allowed to connect Solis data loggers. It is forbidden to be used for other purposes.

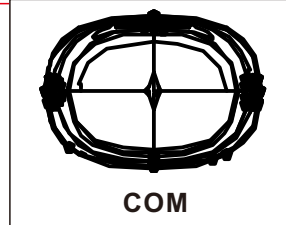
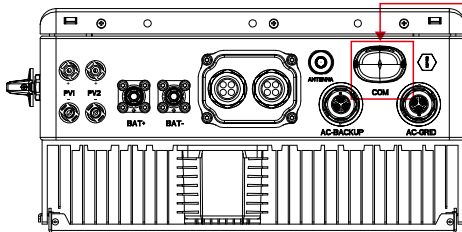

Figure 4.27

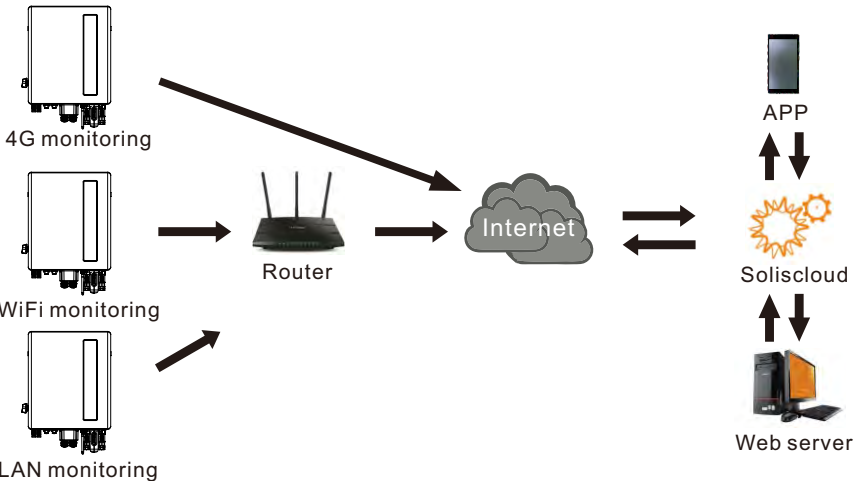

Figure 4.28 Wireless communication function

4.10 External Residual Current Device(RCD)

All series of Solis inverters are integrated with an internal residual current device to protect against any potential d.c component and a.c component of residual current. Therefore, all Solis inverters, due to the design, are not able to feed in DC fault current to the system which fully complies with IEC60364-7-712.

If an external RCD is required to be installed by local regulations, Solis recommends installing a Type-A RCD with a threshold current higher than 100mA.

4.11 Max. over current protection device (OCPD)

To protect the inverter's AC grid connection conductors, Solis recommends installing AC breakers that will protect against overcurrent. The following table defines OCPD ratings for these inverters.

Inverter	Rated voltage	Rated output current	Max. input current	Current for protection device
S6-EH1P3K-L-AU	230V	13.0A	20.0A	25A
S6-EH1P3.6.K-L-AU	230V	15.7A	24.6A	30A
S6-EH1P4.6K-L-AU	230V	20.0A	31.4A	40A
S6-EH1P5K-L-AU	230V	21.7A	32.0A	40A
S6-EH1P6K-L-AU	230V	26.1A	40.0A	50A

Table 4.7 Rating of grid OCPD

4.12 Earth Fault Alarm

Solis inverters fully comply with IEC62109-2 in terms of earth fault alarm (PV insulation detection and protection). When the earth fault on PV side happens, the yellow alarm indicator will flash and the alarm code "PVISO-PRO" will show up on the APP.

Inverter should be installed in a high traffic area to ensure the alarm to be noticed.

The inverter can't start to generate until the earth fault is resolved. Please refer to the troubleshooting section of this manual to resolve the earth fault or contact Solis service team for help.

For the earth fault happened on battery inputs, customer shall install external alarm and monitoring device to comply AS/NZS 5139.

5.1 Preparation

- Ensure all the devices are accessible for operation, maintenance and service.
- Check and confirm that the inverter is firmly installed.
- Space for ventilation is sufficient for one inverter or multiple inverters.
- Nothing is left on the top of the inverter or battery module.
- Inverter and accessories are correctly connected.
- Cables are routed in safe place or protected against mechanical damage.
- Warning signs and labels are suitably affixed and durable.
- Bluetooth Antenna has been connected to the Antenna port of the inverter.
- An Android or IOS mobile phone with Bluetooth function is available.
- Measure DC voltage of PV strings and battery and ensure the polarity is correct.
- Measure AC voltage and frequency and ensure they are within local standard.

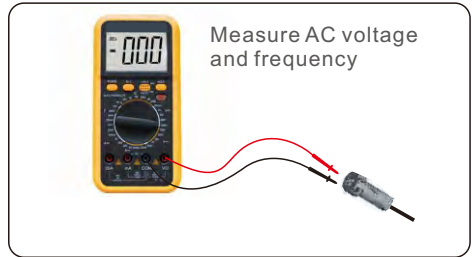
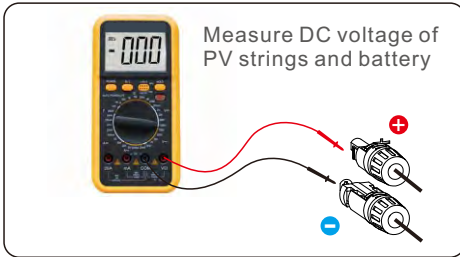

5.2 APP Download

Users need to download the APP before installing it for the first time.

There are three ways to download and install the latest APP:

1. You can visit www.soliscloud.com to download the latest version APP.
2. You can search “**Soliscloud**” in Google Play or App Store.
3. You can scan this QR code below to download “**Soliscloud**”.



6.1 Power On

This inverter can be powered on by PV only, battery only and Grid only. It is suggested that turn on the battery firstly, then set the parameters. After setting, turn on PV and GRID breakers to check whether the system runs properly.

When the inverter is powered on, the five indicators will be lighted at once.

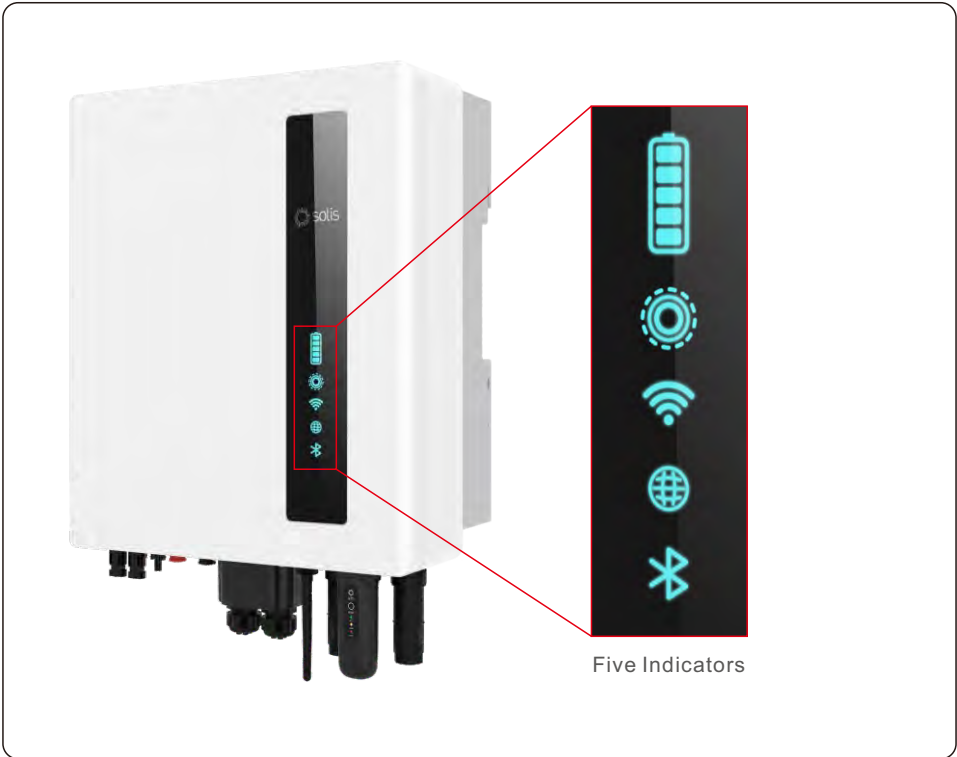

6.2 Log in the APP via bluetooth

Step 1: **Connect with Bluetooth.**

Turn on Bluetooth switch on your mobile phone and then open the Soliscloud APP. Click "More Tools"->"Local Operation"->"Connect with Bluetooth"

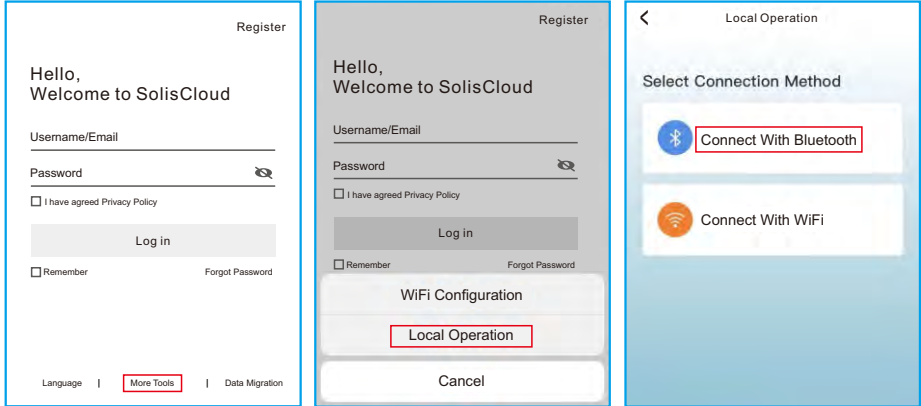

Step 2: Select the Bluetooth signal from the inverter. (Bluetooth Name: Inverter SN)



Step 3: **Login account.**

If you are the installer, please select the account type as Installer. If you are the plant owner, please select the account type as owner. Then set your own initial password for control verification. (The first log-in must be finished by installer in order to do the initial set up)

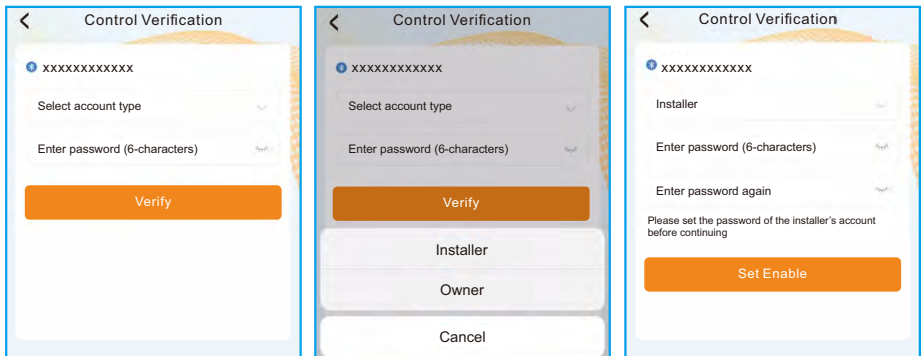

6.3 Initial set up

After the log in for the first time, there is a setup wizard need to be finished.

Inverter Time -> Battery Model -> Meter Setting -> Grid Code -> Work mode

Step 4.1: Set the inverter Date and Time.

You can set to follow the time on your mobile phone.

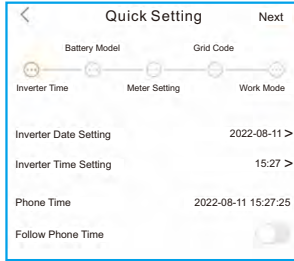

Step 4.2: Set the battery model.

It must be based on the battery model that is actually connected to the inverter.

If there is no battery connected for the moment, please select “No Battery” to avoid alarms. For specific battery setting, please refer to the battery setting in the page 42.

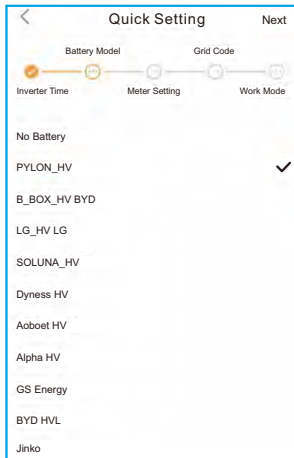

Step 4.3: Set the meter setting.

- Meter Type need to be set. It must be based on the meter type that is actually connected to the inverter.
- Meter Installation Location need to be set. It is suggested to install the meter at the system grid connection point and select “Meter in Grid”

If there is no meter connected for the moment, please select “No Meter” to avoid alarms.

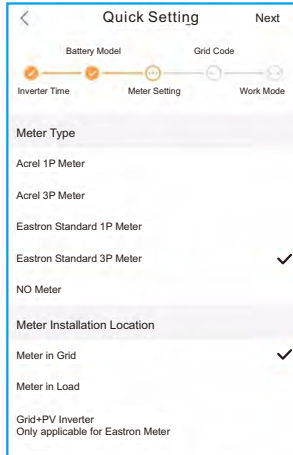

Meter Recommend

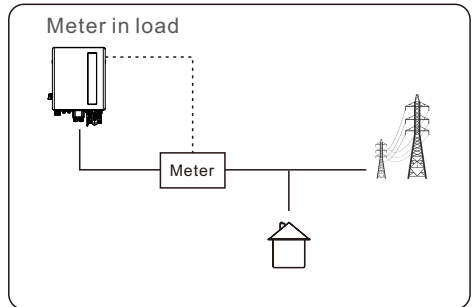
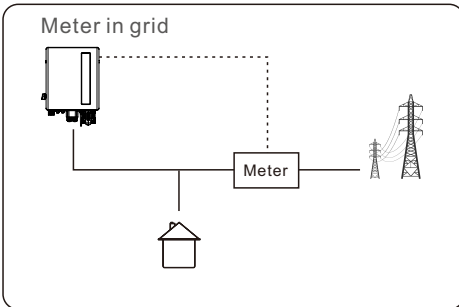

Step 4.4: Set the grid code setting.

Please select the grid code based on the local grid network requirements.

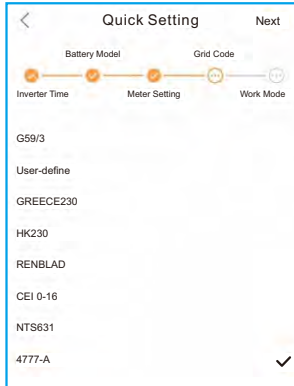

Step 4.5: Set the work mode setting.

There are 4 work mode that can be set.

- Work mode1: Self-Use Mode (default)
- Work mode2: Feed in Priority Mode
- Work mode3: Backup Mode
- Work mode4: Off-grid Mode

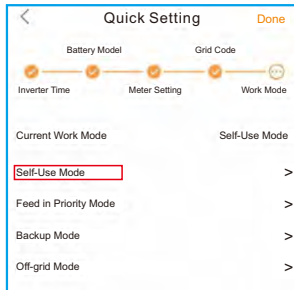

Work mode1: Self-Use Mode (default)

Recommended setting is Self-Use Mode.

This mode can maximize the use of PV power generation for household electricity, or store it in batteries and use it for household electricity.

If need manually control the battery charging and discharging with respect to time, please use the Time of Use switch and the following set points.

The “Allow Grid Charging” is recommended to be turned on (If turned off, the inverter will not force charge the battery and battery could potentially go to sleep).

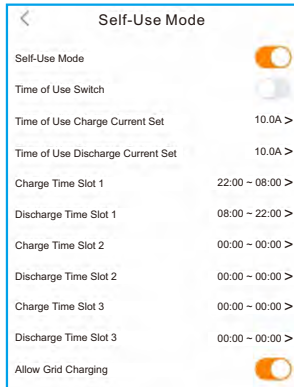

Work mode2: Feed in Priority Mode

This mode can preferentially sends power to the grid when the load is met, used in areas where there is a subsidy for power to the grid.

If need manually control the battery charging and discharging with respect to time, please use the Time of Use switch and the following set points.

The “Allow Grid Charging” is recommended to be turned on (If turned off, the inverter will not force charge the battery and battery could potentially go to sleep).

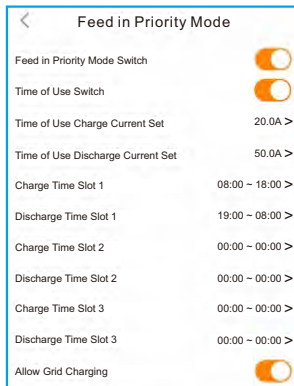

Work mode3: Backup Mode

This mode can coexist with Self-use or Feed in priority and is only suitable for lithium battery. In this mode, part of the battery capacity is reserved for the Backup load in case of power failure. The Backup SOC needs to be set to define the capacity to retain the battery. The "Allow Grid Charging" is recommended to be turned on.

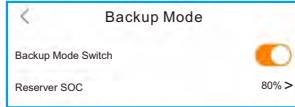

Work mode4: Off-Grid Mode

This mode is only used for pure off-grid and is not recommended for normal storage systems. Note that if this mode is enabled in the grid-connected state, the working logic of the machine will be confused and the "Off-grid" will be displayed.

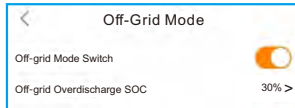

Step 5: Setup complete.

Now the initial settings on the inverter have been set and you can switch on the inverter DC switch and switch on battery breaker to start up the system. You can also explore in the APP to check the operating data, alarm message or other advanced settings.

App Interface Structure

The interface structure of APP is shown as follows.

Check system data, equipment information, and alarms on Overview and Parameters interface. Set system equipment parameters on Setting interface.

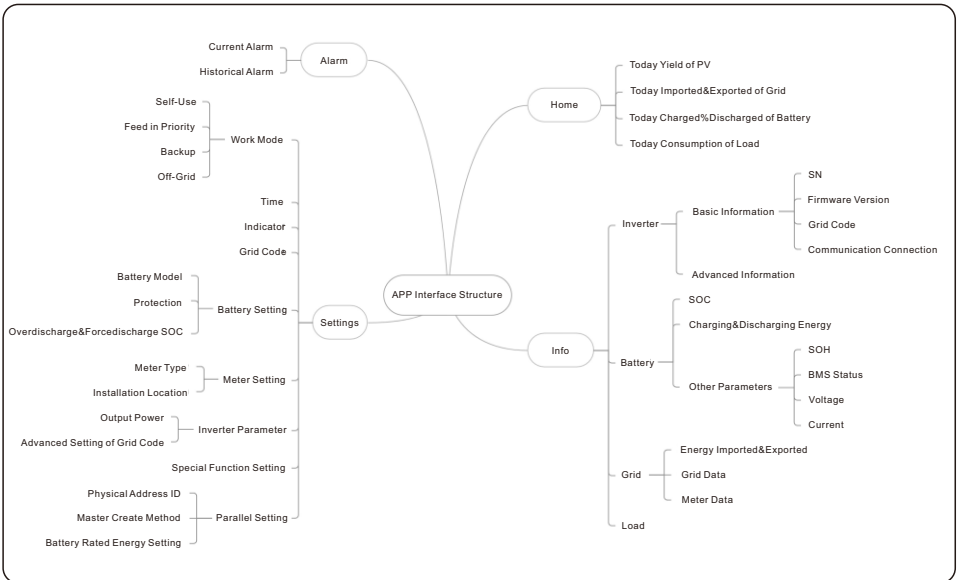

Energy flow diagram

The home page can display the working state, Today Yield of PV, Today Imported/Exported of Grid, Today Charged/Discharged of battery and Today Consumption of household electricity.

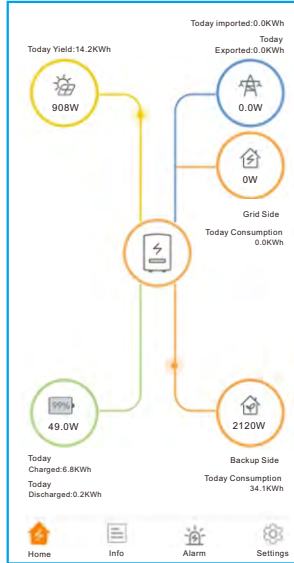







Information

The Inverter page can display basic information such as historical yield, today PV input power, Inverter SN, rated power, model number, DSP/HMI firmware version, grid code and communication connection. The advanced information is authorized by the installer.





Inverter	Battery	Grid	Load
Total Yield		221kWh	
14.2kWh	191kWh	221kWh	
Today Yield	This Month Yield	This Year Yield	
12.8kWh	30kWh	0kWh	
Yesterday Yield	Last Month Yield	Last Year Yield	
View Historical Yield >			
Total PV Input Power		865W	
	Voltage	Current	Power
Pv1	432.6V	2.0A	865.20W
Pv2	0.0V	0.0A	0.00W
Inverter SN	103115022B100041		
Inverter Time	2022-12-23 15:32:03		
Rated Power	6kW		
Model Number	3115		
DSP Firmware Version	V2		
HMI Firmware Version	V1		
HMI Firmware Subversion	Vd		
Grid Code	G59/3		
Communication Connection	>		
Advanced Information	>		
Home	Info	Alarm	Settings

The Battery page can display charging&Discharging power, battery SOC, Charging& Discharging Energy, Other Parameters(From BMS), Other Parameters(From inverter).





Inverter	<u>Battery</u>	Grid	Load
	 49W Discharge Power	 99% Battery SOC	
	Charged	Discharged	
Today	6.8kWh	0.2kWh	
Total	1830kWh	1536kWh	
Other Parameters(From BMS)			
Battery SOH		100%	
Battery Model		Dyness LV	
BMS Status		Normal	
Battery Voltage BMS		50.28V	
Battery Current BMS		0.0A	
BMS Charge Current Limit		10.0A	
BMS Discharge Current Limit		75.0A	
Other Parameters(From inverter)			
Battery Voltage		49.8V	
Battery Current		1.0A	
OverVoltage Protection Value		60.0V	
UnderVoltage Protection Value		42.0V	
Battery Equalization Voltage		53.5V	
 Home	 Info	 Alarm	 Settings

The grid page can display Energy Imported&Exported, Grid Data and Meter data.

Inverter	Battery	<u>Grid</u>	Load
		Exported	Imported
Today	0.0kWh	0.0kWh	
Yesterday	0.0kWh	0.0kWh	
Total	1kWh	0kWh	
Grid Data			
Power			-1399W
Voltage			220.8V
Frequency			49.95Hz

 Home	 Info	 Alarm	 Settings
--	--	---	--

The Load page can display the load power consumption in the grid side and the backup side.

Inverter	Battery	Grid	<u>Load</u>
Grid Side			
Grid Load Power(Active)			0W
Total Grid Load Consumption			0kWh
Today Grid Load Consumption			0.0kWh
This Month Grid Load Consumption			0kWh
This Year Grid Load Consumption			0kWh
Backup Side			
Backup Load Power(Active)			2119W
Total Backup Load Consumption			1527kWh
Today Backup Load Consumption			34.2kWh
This Month Backup Load Consumption			1202kWh
This Year Backup Load Consumption			1527kWh
 Home	 Info	 Alarm	 Settings

Settings

Mode Setting

The interface can display the current work mode, Self-Use/Feed in Priority/Backup/Off-Grid.

Please refer to page 32-33 for specific introduction.

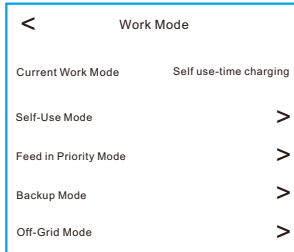

Grid Code Setting

Please select the Grid code you need.

Grid Code Setting	
Grid Code	G59/3 >
OV-G-V 01	262.2V >
OV-G-V-T 01	1.00s >
OV-G-V 02	273.7V >
OV-G-V-T 02	0.50s >
UN-G-V 01	200.1V >
UN-G-V-T 01	2.50s >
UN-G-V 02	184.0V >
UN-G-V-T 02	0.50s >
OV-G-F 01	51.50Hz >
OV-G-F-T 01	90.00s >
OV-G-F 02	52.00Hz >
OV-G-F-T 02	0.50s >
UN-G-F 01	47.50Hz >
UN-G-F-T 01	20.00s >
UN-G-F 02	47.00Hz >
UN-G-F-T 02	0.50s >
Startup-VH	253.0V >
Startup-VL	195.5V >
Recover-VH	253.0V >
Recover-VL	195.5V >
Startup-FH	50.50Hz >
Startup-FL	47.50Hz >
Recover-FH	50.50Hz >
Recover-FL	47.50Hz >
Startup-T	10s >
Restore-T	10s >

Battery Setting

Battery Model: select the battery model to be connected.

Battery Over-voltage/Under-voltage Protection: fill in the appropriate data to protect the battery and extend its life.

Over-discharge SOC: when the battery is discharged to the over-discharge SOC, the battery will not discharge actively.(Due to the internal current conduction, there is a small self-consumption power, if not charged for a long time, the SOC will slowly continue to decline.)

Force-charge SOC: due to the battery power consumption, when the over-discharge SOC drops to the force-charge SOC, the inverter will directly charge the battery according to the maximum battery charging current until the battery SOC reaches the over-discharge SOC.(The charging power is not limited to sources, which may be from PV or from the grid. If "Charging form grid" is set to "Not Allow",the charging logic may not be implemented.) It is not recommended to set the over-discharge&force-charge SOC to the same value, which may cause frequent charging and discharging.

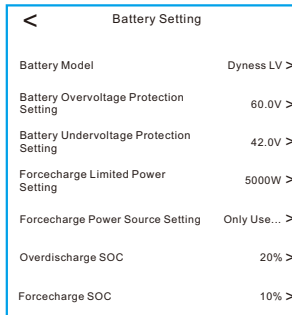

Meter Setting

Meter type: please select a correct meter type. The wrong option will cause the meter RS485 communication Failed. If the battery and meter are not connected, you can select the "NO Meter" to shield the alarm of meter communication fault.

Meter Installation Location: Meter in Grid/Meter in Load/Grid +PV inverter.

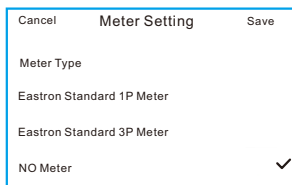

Backup Setting

Backup Port Enabling Setting: please turn on it if the Backup port is needed.

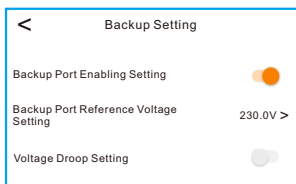

Alarm

The Alarm page can display the Current Alarm(unsolved faults) and the Historical Alarm (resolved faults).

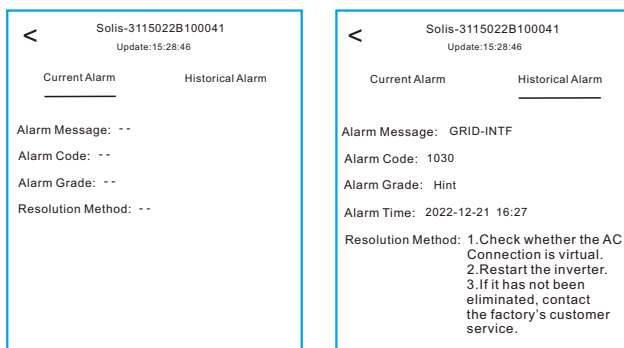

Changed password

When the password of the owner or the installer needs to be reset, please long press the states indicator for 5s.

If the reset command is successfully triggered, the status indicator will be blue and blink for 3s at the frequency of 0.5s, then restore the original state of the indicator.

If the command fails to be triggered, the status indicator will be yellow and blink for 3s at the frequency of 0.5s, then restore the original state of the indicator.

If the command is successfully triggered, the Bluetooth password can be reset in the APP.

6.4 Startup procedure

- Step 1. Turn on the PV DC switch
- Step 2. Turn on the battery breaker or battery switch button on the battery.
- Step 3. Switch on the AC backup and AC grid
- Step 4. Waiting for inverter initializing.

6.5 Shutdown procedure

- Step 1. Turn off the AC circuit breaker at the grid-connection point.
- Step 2. Turn off the DC switch of the inverter.
- Step 3. Turn off the battery circuit breaker.
- Step 4. Wait until the device is powered off and the system is shut down.

6.6 Australian Grid Code Settings

Customers can follow the quick setting process to select the corresponding grid codes based on AS/NZS4777.2:2020 (4777-A/ 4777-B/ 4777-C/ 4777-N).

Or modify the grid code in following path in the APP: Settings -> Grid Code Setting

NOTE:



The standard code selection “4777-A”, “4777-B”, “4777-C” and “4777-N” already have preset default settings as required by AS/NZS 4777.2:2020. Unless specially required, customers do not need to gain access to the following sections or modify any settings inside.

Region	Australia A	Australia B	Australia C	New Zealand	
Standard Code Name	4777-A	4777-B	4777-C	4777-N	Setting Range
OV-G-V1	265V	265V	265V	265V	230-276V
OVG1-T	1.5S	1.5S	1.5S	1.5S	1-2S
OV-G-V2	275V	275V	275V	275V	230-276V
OVG2-T	0.1S	0.1S	0.1S	0.1S	0.1-2S
UN-G-V1	180V	180V	180V	180V	38-230V
UNGV1-T	10S	10S	10S	10S	10-11S
UN-G-V2	70V	70V	70V	70V	38-230V
UNGV2-T	1.5S	1.5S	1.5S	1.5S	1-2S
OV-G-F1	52HZ	52HZ	55HZ	55HZ	50-55HZ
OVG1-T	0.1S	0.1S	0.1S	0.1S	0.1-2S
OV-G-F2	52HZ	52HZ	55HZ	55HZ	50-55HZ
OVG2-T	0.1S	0.1S	0.1S	0.1S	0.1-2S
UN-G-F1	47HZ	47HZ	45HZ	45HZ	45-50HZ
UNGF1-T	1.5S	1.5S	5S	1.5S	1-6S
UN-G-F2	47HZ	47HZ	45HZ	45HZ	45-50HZ
UNGF2-T	1.5S	1.5S	5S	1.5S	1-6S
Startup-T	60S	60S	60S	60S	10-600S
Restore-T	60S	60S	60S	60S	10-600S
Recover-VH	253V	253V	253V	253V	230-276V
Recover-VL	205V	205V	205V	196V	115-230V
Recover-FH	50.15Hz	50.15Hz	50.15Hz	50.15Hz	50-52Hz
Recover-FL	47.5Hz	47.5Hz	47.5Hz	47.5Hz	47-50Hz
Start-VH	253V	253V	253V	253V	230-276V
Start-VL	205V	205V	205V	196V	115-230V
Start-FH	50.15Hz	50.15Hz	50.15Hz	50.15Hz	50-52Hz
Start-FL	47.5Hz	47.5Hz	47.5Hz	47.5Hz	47-50Hz

6.6.1 Working Mode Set

Solis AU version inverters have the following working mode settings:

1. Null
2. Volt-Watt
3. Volt-Var
4. Fixed PF
5. Fixed Reactive

The setting path in the APP is: Settings-> Inverter Parameter Setting -> Advanced Setting of Grid Code -> Work Mode Setting

1. NULL

Description: Inverter will not be under any working mode.

2. Volt-Watt

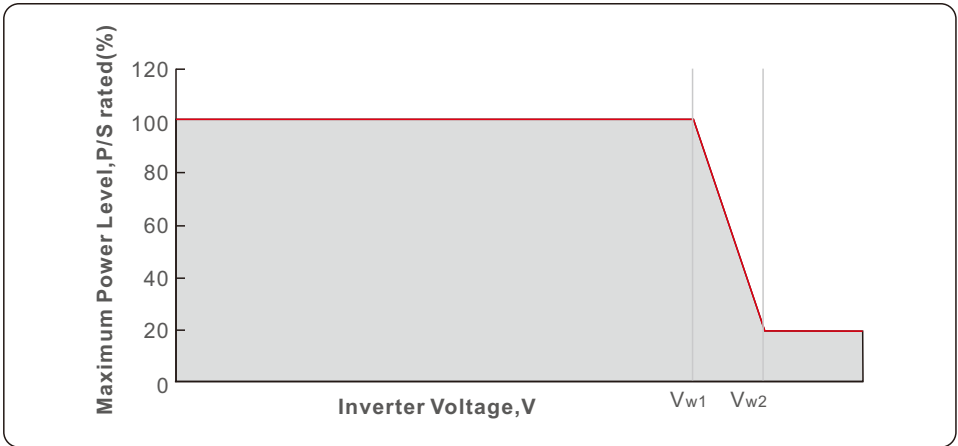

Status: Enable/Disable (Note: This is used to enable or disable the Volt-Watt mode)

Voltage 1: 207V

P-Limit 1: 100%

Voltage 2: 220V

P-Limit 2: 100%

Voltage 3 (V_{w1}):

235-255V (Default: 4777-A(253V); 4777-B(250V);4777-C(253V);4777-N(242V))

P-Limit 3: 100%

Voltage 4 (V_{w2}):

240-265V (Default: 4777-A(260V); 4777-B(260V);4777-C(260V);4777-N(250V))

P-Limit 4: 0%-20% (Default: 20% for 4777-A; 4777-B; 4777-C; 4777-N)

3. Volt-Var

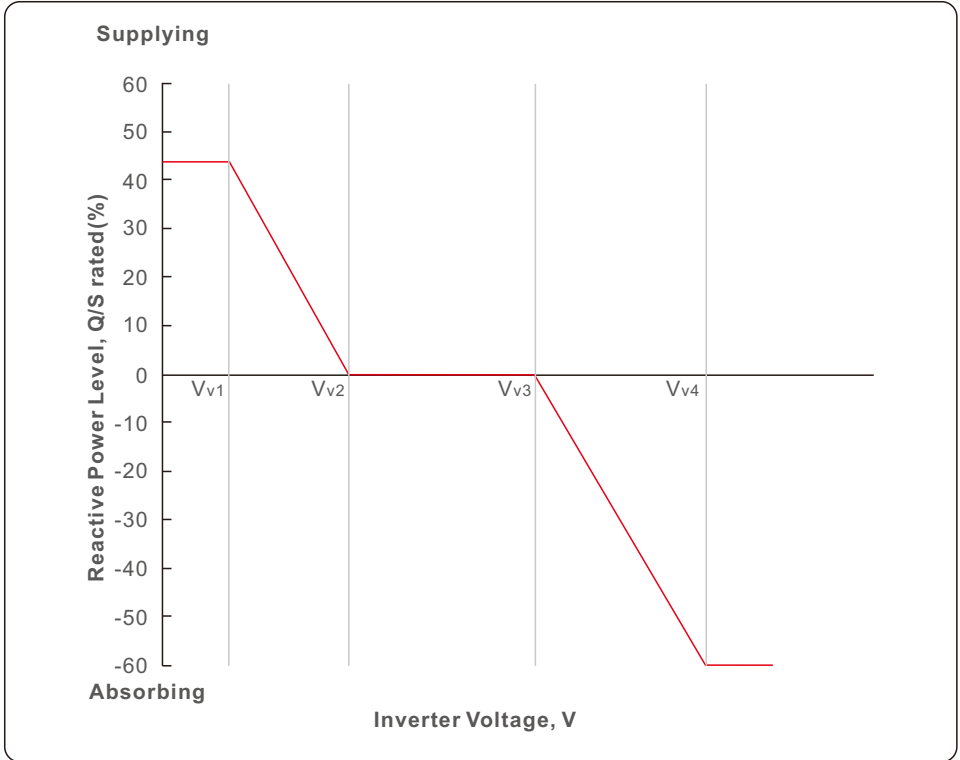

Voltage 1 (Vv1):

180-230V (Default: 4777-A(207V); 4777-B(205V);4777-C(215V);4777-N(207V))

Voltage 2(Vv2) :

180-230V (Default: 4777-A(220V); 4777-B(220V);4777-C(230V);4777-N(220V))

Voltage 3(Vv3) :

230-265V (Default: 4777-A(240V); 4777-B(235V);4777-C(240V);4777-N(235V))

Voltage 4(Vv4) :

230-265V (Default: 4777-A(258V); 4777-B(255V);4777-C(255V);4777-N(244V))

Leading(Supplying) :

+30~+60% (Default: 4777-A(+44%); 4777-B(+30%);4777-C(+44%);4777-N(+60%))

Lagging(Absorbing) :

-30%~-60% (Default: 4777-A(-60%); 4777-B(-40%);4777-C(-60%);4777-N(-60%))

4. Fixed PF

Description: This mode is to set a fixed power factor output

Range: -0.8~+0.8

Default: 1

5. Fixed Reactive

Description: This mode is to set a fixed reactive power output

Range:-60%~+60%

Default: 0%

6.6.2 Power Rate Limit

Settings-> Inverter Parameter Setting -> Advanced Setting of Grid Code->Power Limit

To set the power rate limits for increase and decrease in power level per minute.

Wgra+: 5-100%, Default: 16%

Wgra-: 5-100%, Default: 16%

6.6.3 Freq Derate Set

Settings-> Inverter Parameter Setting -> Advanced Setting of Grid Code->

Frequency Derating Setting

To set the frequency response limits for response to a decrease/increase in frequency.

OVF_Start(F_ULCO): 50.1Hz~50.5Hz

(Default: 4777-A(50.25Hz), 4777-B(50.15Hz), 4777-C(50.5Hz), 4777-N(50.2Hz))

OVF_Stop(F_Pmin): 51Hz~53Hz

(Default: 4777-A(52Hz), 4777-B(52Hz), 4777-C(53Hz), 4777-N(52Hz))

UNF_Start(F_LLCO): 49.5Hz~49.9Hz

(Default: 4777-A(49.75Hz), 4777-B(49.85Hz), 4777-C(49.5Hz), 4777-N(49.8Hz))

UNF_Stop(F_Pmax): 47Hz~49Hz

(Default: 4777-A(48Hz), 4777-B(48Hz), 4777-C(47Hz), 4777-N(48Hz))

6.6.4 10mins Voltage Set

Settings-> Inverter Parameter Setting -> Advanced Setting of Grid Code->Special Setting
-> 10min Overvoltage Setting

To set the 10mins average protection limit.

Range: 244V to 258V

Default: 4777-A (258V); 4777-B(258V); 4777-C(258V); 4777-N(249V)

6.6.5 DRM Settings

Settings-> Inverter Parameter Setting -> Advanced Setting of Grid Code->DRM Setting
"DRM ON/OFF" is used to enabled or disable the functionality of the DRM port.

6.7 Export Power Control

The export power control function is designed to comply with AS/NZS4777.2:2020. When customer select the grid code "4777-A", "4777-B", "4777-C", "4777-N", customer can find the export power control settings in the follow path on the APP: Settings-> System Export Power Setting.

Following parameters can be found on the APP and the functions are explained below:

Parameters	Functions	Setting Range
System Export Power Limit Switch	Enable/Disable the export power control function	ON/OFF
System Export Power Limit Value	The soft backflow power limit. Inverter will dynamically control the inverter output to meet the system export power limit	0~Inverter Max Output Power
System Export Power Hard Limit Switch	Enable/Disable the export power control hard limit	ON/OFF
System Export Power Hard Limit Value	The hard backflow power limit. If the System Export Power Hard Limit Switch is enabled and hard limit value is reached, inverter will shut down within 5s and give alarm as "EPM-Hard Limit"	0~Inverter Max Output Power

Solis S6 Series inverter does not require any regular maintenance. However, cleaning the heatsink will help the inverter dissipate heat and increase the lifetime of inverter. The dirt on the inverter can be cleaned with a soft brush.



CAUTION:

Do not touch the surface when the inverter is operating. Some parts may be hot and could cause burns. Turn OFF the inverter and let it cool down before you do any maintenance or cleaning of inverter.

The Screen and the LED status indicator lights can be cleaned with cloth if they are too dirty to be read.



Note:

Never use any solvents, abrasives, or corrosive materials to clean the inverter.

7.1 Smart O&M

In order to improve our products and provide you with higher quality services, this device has a built-in data logging module for collecting relevant information during operation (such as power generation data, fault data)

Commitment:

1. We will only collect, use and process your device information for the purpose of improving our products and services.
2. We will take all reasonable and feasible measures to ensure that no irrelevant information is collected and we will protect your device information.
3. We will not share, transfer or disclose the collected device information with any company, organization or individual.
4. When we stop operating products or services, we will stop collecting your device information in a timely manner.
5. If you do not want to provide such information, you can notify our company to turn off this function, which will not affect your normal use of other functions of the product.

8. Troubleshooting

Message Name	Information Description	Troubleshooting Suggestion
Off	Control device to shutdown	1. Turn on the device in the ON/OFF Setting.
LmtByEPM	The device's output is under controlled	<ol style="list-style-type: none"> 1. Confirm whether the inverter is connected to an external EPM/meter to prevent reverse current. 2. Confirm whether the inverter is controlled by an external third-party device. 3. Confirm whether the power setting of the inverter power control is limited. 4. Verify settings in section 6.6.7 and check your meter readings.
LmtByDRM	DRM Function ON	1. No need to deal with it.
LmtByTemp	Over temperature power limited	1. No need to deal with it, the device is in normal operation.
LmtByFreq	Frequency power limited	
LmtByVg	The device is in the Volt-Watt mode	<ol style="list-style-type: none"> 1. Due to the requirements of local safety regulations, when the grid voltage is high, the Volt-watt working mode is triggered, which generally does not need to be dealt with. 2. Inverter factory test errors causing this mode to open, if you need to close, you can close this mode in LCD, set the process: Main menu → Advanced Settings → Password 0010 → STD mode settings → Working Mode → Working mode: NULL → Save and exit.
LmtByVar	The device is in the Volt-Var mode of operation	<ol style="list-style-type: none"> 1. Due to the requirements of local safety regulations, when the grid voltage is high, the Volt-watt working mode is triggered, which generally does not need to be dealt with. 2. Inverter factory test errors causing this mode to open, if you need to close, you can close this mode in LCD, set the process: Main menu → Advanced Settings → Password 0010 → STD mode settings → Working Mode → Working mode: NULL → Save and exit.
LmtByUnFr	Under frequency limit	1. No need to deal with it.
Standby	Bypass run	
StandbySynoch	Off grid status to On grid status	
GridToLoad	Grid to load	

8. Troubleshooting

Message Name	Information Description	Troubleshooting Suggestion
Surge Alarm	On-site grid surge	1. Grid side fault, restart the device. If it is still not eliminated, please contact the manufacturer's customer service.
OV-G-V01	Grid voltage exceeds the upper voltage range	1. Confirm whether the power grid is abnormal. 2. Confirm that the AC cable is properly connected. 3. Restart the system and check if the fault persists.
UN-G-V01	Grid voltage exceeds the lower voltage range	
OV-G-F01	Grid frequency exceeds the upper frequency range	
UN-G-F01	Grid frequency exceeds the lower frequency range	
G-PHASE	Unbalanced grid voltage	
G-F-GLU	Grid voltage frequency fluctuation	
NO-Grid	No grid	
OV-G-V02	Grid transient overvoltage	
OV-G-V03	Grid transient overvoltage	1. Restart the system, confirm if that the fault continues.
IGFOL-F	Grid current tracking failure	1. Confirm whether the power grid is abnormal. 2. Confirm that the AC cable is properly connected. 3. Restart the system and check if the fault persists.
OV-G-V05	Grid voltage RMS instantaneous overvoltage fault	
OV-G-V04	Grid voltage exceeds the upper voltage range	
UN-G-V02	Grid voltage exceeds the lower voltage range	
OV-G-F02	Grid frequency exceeds the upper frequency range	
UN-G-F02	Grid frequency exceeds the lower frequency range	
NO-Battery	Battery is not connected	1. Check on information page 1 – Verify the battery voltage is within standards. 2. Measure battery voltage at plug.
OV-Vbackup	Inverting overvoltage	1. Check whether the backup port wiring is normal 2. Restart the system, confirm that the fault continues.
Over-Load	Load overload fault	1. Backup load power is too large, or some inductive load startup power is too large, need to remove some backup load, or remove the inductive load on the backup.

Message Name	Information Description	Troubleshooting Suggestion
BatName-FAIL	Wrong battery brand selection	1. Confirm whether the battery model selection is consistent with the actual one.
CAN Fail	CAN Fail	1. Can failure is a failure of communication between inverter and battery. Check cable conditions. Check to ensure you have it plugged in on the CAN port of the battery and inverter. Check that you are using the right cable. Some batteries require a special battery from the battery manufacturer.
OV-Vbatt	Battery overvoltage detected	1. Verify battery voltage is within standards. Measure battery voltage at inverter connection point. Contact your battery manufacturer for further service.
UN-Vbatt	Battery undervoltage detected	1. Restart the system and check if the fault persists. If it is still not eliminated, please contact the manufacturer's customer service.
Fan Alarm	Fan alarm	1. Check if the internal fan is working correctly or jammed.
OV-DC01 (1020 DATA:0001)	DC 1 input overvoltage	1. Check if the PV voltage is abnormal 2. Restart the system, confirm that the fault continues
OV-DC02 (1020 DATA:0002)	DC 2 input overvoltage	
OV-BUS (1021 DATA:0000)	DC bus overvoltage	1. Restart the system, confirm that the fault continues.
UN-BUS01 (1023 DATA:0001)	DC bus undervoltage	
UNB-BUS (1022 DATA:0000)	DC bus unbalanced voltage	
UN-BUS02 (1023 DATA:0002)	Abnormal detection of DC bus voltage	
DC-INTF. (1027 DATA:0000)	DC hardware overcurrent (1, 2, 3, 4)	1. Check if the DC wires are connected correctly without loose connection.
OV-G-I (1018 DATA:0000)	Aphase RMS value overcurrent	1. Confirm that the grid is abnormal. 2. Confirm that the AC cable connection is not abnormal. 3. Restart the system, confirm that the fault continues.
OV-DCA-I (1025 DATA:0000)	DC 1 average overcurrent	1. Restart the system, confirm that the fault continues.
OV-DCB-I (1026 DATA:0000)	DC 2 average overcurrent	
GRID-INTF. (1030 DATA:0000)	AC hardware overcurrent (abc phase)	

Message Name	Information Description	Troubleshooting Suggestion
DCInj-FAULT (1037 DATA:0000)	The current DC component exceeds the limit	<ol style="list-style-type: none"> 1. Confirm that the grid is abnormal. 2. Confirm that the AC cable connection is not abnormal. 3. Restart the system, confirm that the fault continues.
IGBT-OV-I (1048 DATA:0000)	IGBT overcurrent	<ol style="list-style-type: none"> 1. Restart the system, confirm that the fault continues.
OV-TEM (1032 DATA:0000)	Module over temperature	<ol style="list-style-type: none"> 1. Check whether the surrounding environment of the inverter has poor heat dissipation. 2. Confirm whether the product installation meets the requirements.
RelayChk-FAIL (1035 DATA:0000)	Relay failure	<ol style="list-style-type: none"> 1. Restart the system, confirm that the fault continues.
UN-TEM (103A DATA:0000)	Low temperature protection	<ol style="list-style-type: none"> 1. Check the working environment temperature of the inverter. 2. Restart the system to confirm if the fault continues.
PV ISO-PRO01 (1033 DATA:0001)	PV negative ground fault	<ol style="list-style-type: none"> 1. Check whether the PV strings have insulation problems. 2. Check whether the PV cable is damaged.
PV ISO-PRO02 (1033 DATA:0002)	PV positive ground fault	
12Power-FAULT (1038 DATA:0000)	12V undervoltage failure	<ol style="list-style-type: none"> 1. Check current leakage to ground. Verify your grounding. Verify all wires are in good condition and not leaking current to ground.
ILeak-PRO01 (1034 DATA:0001)	Leakage current failure 01 (30mA)	
ILeak-PRO02 (1034 DATA:0002)	Leakage current failure 02 (60mA)	
ILeak-PRO03 (1034 DATA:0003)	Leakage current failure 03 (150mA)	
ILeak-PRO04 (1034 DATA:0004)	Leakage current failure 04	
ILeak_Check (1039 DATA:0000)	Leakage current sensor failure	
GRID-INTF02 (1046 DATA:0000)	Power grid disturbance 02	<ol style="list-style-type: none"> 1. Confirm whether the grid is seriously distorted. 2. Check whether the AC cable is connected reliably.
OV-Vbatt-H/ OV-BUS-H (1051 DATA:0000)	Battery overvoltage hardware failure / VBUS	<ol style="list-style-type: none"> 1. Check if the battery circuit breaker is tripping. 2. Check if the battery is damaged.

Message Name	Information Description	Troubleshooting Suggestion
OV-ILLC (1052 DATA:0000)	LLC hardware overcurrent	1. Check whether the backup load is overloaded. 2. Restart the system, confirm that the fault continues.
INI-FAULT (1031 DATA:0000)	AD zero drift overlink	1. Restart the system, confirm that the fault continues.
DSP-B-FAULT (1036 DATA:0000)	The master-slave DSP communication is abnormal	
AFCI-Check (1040 DATA:0000)	AFCI self-test failure	
ARC- FAULT (1041 DATA:0000)	AFCI failure	1. Verify connections are tight within your PV system. Arc fault settings can be changed in advanced settings if further adjustment is necessary.

Table 8.1 Fault message and description



NOTE:

If the inverter displays any alarm message as listed in Table 8.1; please turn off the inverter and wait for 5 minutes before restarting it .
If the failure persists, please contact your local distributor or the service center.

Please keep ready with you the following information before contacting us.

1. Serial number of Solis Singles Phase Inverter;
2. The distributor/dealer of Solis Singles Phase Inverter (if available);
3. Installation date.
4. The description of the problem together with necessary information, pictures, attachment.
5. The PV array configuration (e.g. number of panels, capacity of panels, number of strings, etc.);
6. Your contact details.

9. Specifications

Technical Data	S6-EH1P3K-L-AU	S6-EH1P3.6K-L-AU
Input DC (PV side)		
Recommended max. PV power	4800W	5700W
Max. input voltage	600V	
Rated voltage	330V	
Start-up voltage	90V	
MPPT voltage range	90-520V	
Full load MPPT voltage range	105-520V	125-520V
Max. input current	16A/16A	
Max. short circuit current	24A/24A	
Max. inverter backfeed current to the array	0A	
MPPT number/Max input strings number	2/2	
Battery		
Battery Type	Li-ion / Lead-acid	
Battery Voltage range	42 - 58V	
Battery Capacity	50 - 2000Ah	
Maximum Charging Power	3kW	3.6kW
Maximum Charge/discharge current	62.5A	75A
Communication	CAN	
Output AC(Back-up)		
Rated output power	3kW	3.6kW
Max. apparent output power	4.2 kVA, 60SEC	5 kVA, 60SEC
Back-up switch time	< 10ms	
Rated output voltage	1/N/PE, 230V	
Rated frequency	50Hz	
Rated output current	13.0 A	15.7 A
THDv(@linear load)	3%	
Input AC (Grid side)		
Rated voltage	230V	
Max. input current	20.0 A	24.6 A
Rated frequency	50Hz	

9. Specifications

Technical Data	S6-EH1P3K-L-AU	S6-EH1P3.6K-L-AU
Output AC(Grid side)		
Rated output power	3kW	3.6kW
Max. apparent output power	3kVA	3.6kVA
Operation phase	1/N/PE	
Rated grid voltage	230V	
The grid voltage range	187-253 V	
Rated frequency	50 Hz	
Rated grid output current	13.0 A	15.7 A
Max. output current	13.0 A	15.7 A
Inrush current	65A 10us	
Max. output fault current	65A 10us	
Max. output overcurrent protection	13.0A	15.7A
Power Factor	>0.99 (0.8 leading - 0.8 lagging)	
THDi	<3%	
Efficiency		
Max efficiency	>97.0%	
EU efficiency	>96.2%	
BAT charged by PV Max. efficiency	>94.9%	
BAT charged/discharged to AC Max. efficiency	>94.33%/93.51%	
Protection		
Ground fault monitoring	Yes	
Residual current mornitoring	Yes	
Integrated AFCI	Yes	
DC reverse polarity protection	Yes	
Protection class / Over voltage category	I / II(PV), II(battery), III(AC)	

9. Specifications

Technical Data	S6-EH1P3K-L-AU	S6-EH1P3.6K-L-AU
General data		
Dimensions(W/H/D)	405*480*205mm	
Weight	24.18kg	
Topology	Non-Isolated	
Operation temperature range	-25°C ~ +60°C	
Ingress protection	IP66	
Cooling concept	Natural convection	
Max.operation altitude	3000m	
Active anti-islanding method	Active frequency shifting	
Grid connection standard	G98 or G99, VDE-AR-N 4105 / VDE V 0124, EN 50549-1, VDE 0126 / UTE C 15 / VFR:2019, RD 1699 / RD 244 / UNE 206006 / UNE 206007-1, CEI 0-21, C10/11, NRS 097-2-1, TOR, EIFS 2018.2, IEC 62116, IEC 61727, IEC 60068, IEC 61683, EN 50530, MEA, PEA	
Safty/EMC standard	IEC/EN 62109-1/-2, EN 61000-6-1/-2/-3/-4	
Features		
DC connection	MC4 connector	
AC connection	Quick connection plug	
Display	LED+APP	
Communication	RS485,CAN, Optional: Wi-Fi, GPRS, LAN*	
Warranty	5 years standard (extend to 20 years)	

9. Specifications

Technical Data	S6-EH1P4.6K-L-AU	S6-EH1P5K-L-AU
Input DC (PV side)		
Recommended max. PV power	7000W	8000W
Max. input voltage	600V	
Rated voltage	330V	
Start-up voltage	90V	
MPPT voltage range	90-520V	
Full load MPPT voltage range	160-520V	175-520V
Max. input current	16A/16A	
Max. short circuit current	24A/24A	
Max. inverter backfeed current to the array	0A	
MPPT number/Max input strings number	2/2	
Battery		
Battery Type	Li-ion / Lead-acid	
Battery Voltage range	42 - 58V	
Battery Capacity	50 - 2000Ah	
Maximum Charging Power	4.6kW	5kW
Maximum Charge/discharge current	100A	105A
Communication	CAN	
Output AC(Back-up)		
Rated output power	4.6kW	5kW
Max. apparent output power	6.4 kVA, 60SEC	7 kVA, 60SEC
Back-up switch time	< 10ms	
Rated output voltage	1/N/PE, 230V	
Rated frequency	50Hz	
Rated output current	20.0 A	21.7 A
THDv(@linear load)	3%	
Input AC (Grid side)		
Rated voltage	230V	
Max. input current	31.4 A	32.0 A
Rated frequency	50Hz	

9. Specifications

Technical Data	S6-EH1P4.6K-L-AU	S6-EH1P5K-L-AU
Output AC(Grid side)		
Rated output power	4.6kW	5kW
Max. apparent output power	4.6kVA	5kVA
Operation phase	1/N/PE	
Rated grid voltage	230 V	
The grid voltage range	187-253 V	
Rated frequency	50 Hz	
Rated grid output current	20.0 A	21.7 A
Max. output current	20.0 A	21.7 A
Inrush current	65A 10us	
Max. output fault current	65A 10us	
Max. output overcurrent protection	20.0A	21.7A
Power Factor	>0.99 (0.8 leading - 0.8 lagging)	
THDi	<3%	
Efficiency		
Max efficiency	>97.5%	
EU efficiency	>96.2%	
BAT charged by PV Max. efficiency	>94.9%	
BAT charged/discharged to AC Max. efficiency	>94.33%/93.51%	
Protection		
Ground fault monitoring	Yes	
Residual current mornitoring	Yes	
Integrated AFCI	Yes	
DC reverse polarity protection	Yes	
Protection class / Over voltage category	I / II(PV), II(battery), III(AC)	

9. Specifications

Technical Data	S6-EH1P4.6K-L-AU	S6-EH1P5K-L-AU
General data		
Dimensions(W/H/D)	405*480*205mm	
Weight	24.18kg	
Topology	Non-Isolated	
Operation temperature range	-25°C ~ +60°C	
Ingress protection	IP66	
Cooling concept	Natural convection	
Max.operation altitude	3000m	
Active anti-islanding method	Active frequency shifting	
Grid connection standard	G98 or G99, VDE-AR-N 4105 / VDE V 0124, EN 50549-1, VDE 0126 / UTE C 15 / VFR:2019, RD 1699 / RD 244 / UNE 206006 / UNE 206007-1, CEI 0-21, C10/11, NRS 097-2-1, TOR, EIFS 2018.2, IEC 62116, IEC 61727, IEC 60068, IEC 61683, EN 50530, MEA, PEA	
Safty/EMC standard	IEC/EN 62109-1/-2, EN 61000-6-1/-2/-3/-4	
Features		
DC connection	MC4 connector	
AC connection	Quick connection plug	
Display	LED+APP	
Communication	RS485,CAN, Optional: Wi-Fi, GPRS, LAN*	
Warranty	5 years standard (extend to 20 years)	

9. Specifications

Technical Data	S6-EH1P6K-L-AU
Input DC (PV side)	
Recommended max. PV power	9600W
Max. input voltage	600V
Rated voltage	330V
Start-up voltage	90V
MPPT voltage range	90-520V
Full load MPPT voltage range	210-520V
Max. input current	16A/16A
Max. short circuit current	24A/24A
Max. inverter backfeed current to the array	0A
MPPT number/Max input strings number	2/2
Battery	
Battery Type	Li-ion / Lead-acid
Battery Voltage range	42 - 58V
Battery Capacity	50 - 2000Ah
Maximum Charging Power	6kW
Maximum Charge/discharge current	125A
Communication	CAN
Output AC(Back-up)	
Rated output power	6kW
Max. apparent output power	8 kVA, 60SEC
Back-up switch time	< 10ms
Rated output voltage	1/N/PE, 230V
Rated frequency	50Hz
Rated output current	26.1 A
THDv(@linear load)	3%
Input AC (Grid side)	
Rated voltage	230V
Max. input current	40 A
Rated frequency	50Hz

9. Specifications

Technical Data	S6-EH1P6K-L-AU
Output AC(Grid side)	
Rated output power	6kW
Max. apparent output power	6kVA
Operation phase	1/N/PE
Rated grid voltage	230 V
The grid voltage range	187-253 V
Rated frequency	50 Hz
Rated grid output current	26.1 A
Max. output current	26.1 A
Inrush current	65A 10us
Max. output fault current	65A 10us
Max. output overcurrent protection	26.1A
Power Factor	>0.99 (0.8 leading - 0.8 lagging)
THDi	<3%
Efficiency	
Max efficiency	>97.5%
EU efficiency	>96.2%
BAT charged by PV Max. efficiency	>94.9%
BAT charged/discharged to AC Max. efficiency	>94.33%/93.51%
Protection	
Ground fault monitoring	Yes
Residual current mornitoring	Yes
Integrated AFCI	Yes
DC reverse polarity protection	Yes
Protection class / Over voltage category	I / II(PV), II(battery), III(AC)

9. Specifications

Technical Data	S6-EH1P6K-L-AU
General data	
Dimensions(W/H/D)	405*480*205mm
Weight	24.18kg
Topology	Non-Isolated
Operation temperature range	-25°C ~ +60°C
Ingress protection	IP66
Cooling concept	Natural convection
Max.operation altitude	3000m
Active anti-islanding method	Active frequency shifting
Grid connection standard	G98 or G99, VDE-AR-N 4105 / VDE V 0124, EN 50549-1, VDE 0126 / UTE C 15 / VFR:2019, RD 1699 / RD 244 / UNE 206006 / UNE 206007-1, CEI 0-21, C10/11, NRS 097-2-1, TOR, EIFS 2018.2, IEC 62116, IEC 61727, IEC 60068, IEC 61683, EN 50530, MEA, PEA
Safty/EMC standard	IEC/EN 62109-1/-2, EN 61000-6-1/-2/-3/-4
Features	
DC connection	MC4 connector
AC connection	Quick connection plug
Display	LED+APP
Communication	RS485,CAN, Optional: Wi-Fi, GPRS, LAN*
Warranty	5 years standard (extend to 20 years)

*WIFI/GPRS communication function needs to use the data logger, LAN communication needs to cooperate with the upper PC.

Bluetooth

Frequency range:2400-2483.5MHz

WiFi maximum transmitting power:4dBm

It is recommended to connect a DC Breaker with the corresponding specification outside the battery port.

10.1 Built-In DC Isolator Specification

A DC-PV2 switch , complied to AS60947.3:2018 ,within the inverter, is used as isolating device. Please check below ratings.

DC switch brand	Beijing People
Model	GHX5-32P
PV category	DC-PV2
Ue	1100V
Ie	30A
Ui	1500V
Uimp	8000V
Icw	700A
Icm	1400A
I(make)/Ic(break)	120A
Complied standard	AS 60947.3

Ginlong Technologies Co., Ltd.

No. 188 Jinkai Road, Binhai Industrial Park, Xiangshan, Ningbo,
Zhejiang, 315712, P.R.China.

Tel: +86 (0)574 6578 1806

Fax: +86 (0)574 6578 1606

Email: info@ginlong.com

Web: www.ginlong.com

Please adhere to the actual products in case of any discrepancies in this user manual.

If you encounter any problem on the inverter, please find out the inverter S/N
and contact us, we will try to respond to your question ASAP.

